

# **User's Guide**

## **HP 71910A Wide-Bandwidth Surveillance Receiver**



**HP Part No. 71910-90002  
Printed in USA December 1996**

**Edition A.0.0**

## **Notice**

The information contained in this document is subject to change without notice.

Hewlett-Packard makes no warranty of any kind with regard to this material, including, but not limited to, the implied warranties of merchantability and fitness for a particular purpose. Hewlett-Packard shall not be liable for errors contained herein or for incidental or consequential damages in connection with the furnishing, performance, or use of this material.

## **Restricted Rights Legend.**

Use, duplication, or disclosure by the U.S. Government is subject to restrictions as set forth in subparagraph (c) (1) (ii) of the Rights in Technical Data and Computer Software clause at DFARS 252.227-7013 for DOD agencies, and subparagraphs (c) (1) and (c) (2) of the Commercial Computer Software Restricted Rights clause at FAR 52.227-19 for other agencies.

This instrument has been designed and tested in accordance with IEC Publication 348, *Safety Requirements for Electronic Measuring Apparatus*, and has been supplied in a safe condition. The instruction documentation contains information and warnings which must be followed by the user to ensure safe operation and to maintain the instrument in a safe condition.

©Copyright Hewlett-Packard Company 1994–1996

All Rights Reserved. Reproduction, adaptation, or translation without prior written permission is prohibited, except as allowed under the copyright laws.  
1400 Fountaingrove Parkway, Santa Rosa, CA 95403-1799, USA

---

## Safety

---

**WARNING** No operator serviceable parts inside. Refer servicing to qualified personnel. To prevent electrical shock, do not remove covers.

---

**WARNING** For continued protection against fire hazard, replace line fuse only with same type and ratings (type 6.3A/250V). The use of other fuses or materials is prohibited.

---

**CAUTION** Always use the three-prong ac power cord supplied with this instrument. Failure to ensure adequate earth grounding by not using this cord may cause instrument damage.

---

**WARNING** This is a Safety Class 1 Product (provided with a protective earthing ground incorporated in the power cord.) The mains plug shall only be inserted in a socket outlet provided with a protective earth contact. Any interruption of the protective conductor inside or outside of the instrument is likely to make the instrument dangerous. Intentional interruption is prohibited.

---

**CAUTION** This instrument is designed for use in Installation Category II and Pollution Degree 2 per IEC 1010 and 664 respectively.

---

**CAUTION** **Ventilation Requirements:** When installing the instrument in a cabinet, the convection into and out of the instrument must not be restricted. The ambient temperature (outside the cabinet) must be less than the maximum operating temperature of the instrument by 4 °C for every 100 watts dissipated in the cabinet. If the total power dissipated in the cabinet is greater than 800 watts, then forced convection must be used.

---

**WARNING** If this instrument is not used as specified, the protection provided by the equipment could be impaired. This instrument must be used in a normal condition (in which all means for protection are intact) only.

---

---

## Surveillance with the HP 71910A

The HP 71910A Wide-Bandwidth Surveillance Receiver provides both signal search and signal collection capability from 100 Hz to 26.5 GHz. It is optimized for surveillance and signal monitoring applications. The HP 71910A can be operated in either of the following two instrument modes:

- Spectrum analyzer operation for signal searches
  - Maximum resolution BW ..... 3 MHz
- Wide-bandwidth receiver operation for signal collection
  - IF BW ..... 10 to 100 MHz

---

**Note** When you use the wide-bandwidth surveillance receiver, remember that in spectrum analyzer mode the maximum resolution bandwidth is 3 MHz; it is not a 100 MHz bandwidth spectrum analyzer.

---

The receiver's IF and video outputs can be examined by oscilloscopes, demodulators, digitizers, FFT baseband analyzers, and other instruments.

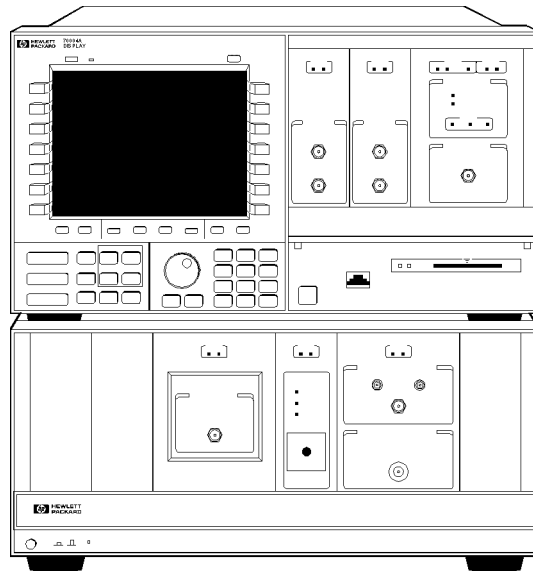

fig16

**HP 71910A Wide-Bandwidth Surveillance Receiver**

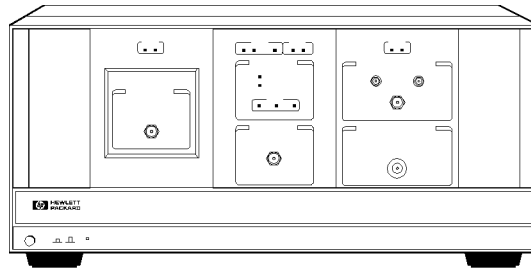

fig17

### HP 71910A Option 011

When first turned on, the wide-bandwidth surveillance receiver operates as a spectrum analyzer. This allows you to view signals across a large frequency range. Once you've located a signal, switch to the fixed-tuned receiver mode to downconvert the signal.

The downconverted signal is available at the rear panel for processing and analyzing by external devices. The Option 011 version of the instrument is primarily used as a collection receiver; it has very limited spectrum analyzer capability due to linear detection and 3 MHz maximum peak detection bandwidth. (Option 013 adds an HP 70902A to provide a more complete spectrum analyzer.)

#### IF outputs are available at the rear panel

In receiver mode, the downconverted signal is available at the instrument's rear panel. The standard rear-panel output is centered at 321.4 MHz. Option 001 and 002 instruments provide additional 70 MHz and 140 MHz IF signals respectively. Refer to Chapter 3 for examples of processing these signals.

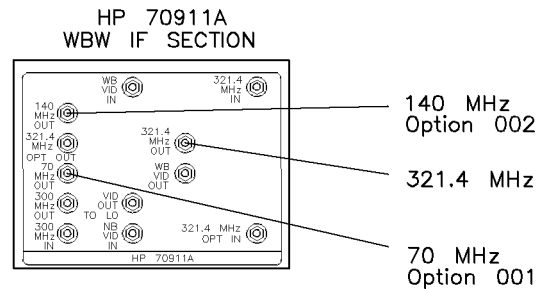

fig19.

## Demodulated outputs are available at the front panel

The front-panel VIDEO connector provides AM and pulse demodulation. Option 004 provides additional I/Q outputs and Option 005 provides an additional FM output. Refer to Chapter 3 for examples of processing these signals.

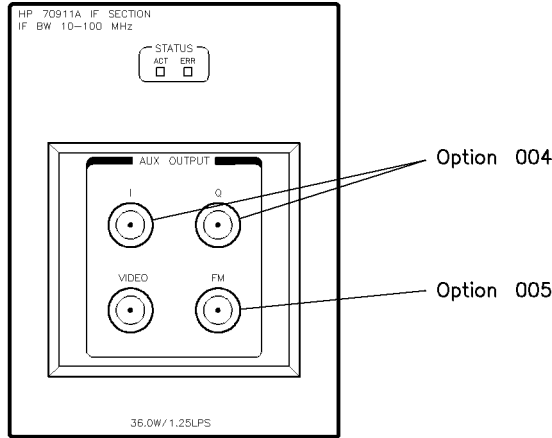
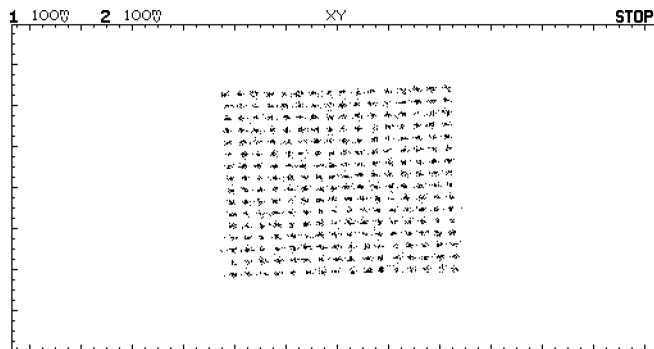

fig2

Option 004 instruments (together with an external oscilloscope in XY mode), provide a convenient method of identifying modulation formats such as 8 PSK, 16 QAM, and 64 QAM. With typical receivers, the constellations “spin” due to the offset in frequency between the receiver and the signal. This makes format identification very difficult. But, because of the wide-bandwidth surveillance receiver’s 1 Hz frequency tuning, this spinning movement can be slowed to the point where it is almost stopped.



256 QAM Constellation Displayed on Oscilloscope

### Switch between operating mode with the press of a button

- Press **USER** and then **RX\_MODE** for use as a wide-bandwidth surveillance receiver.
- Press **MENU** for use as a spectrum analyzer.

This is the default state when the instrument is first turned on.

- Press **DISPLAY** to access functions for controlling the display.

You will seldom need to use this key. For information on functions accessed with this key, refer to the *HP 70004A DISPLAY Operating Manual*.

- Press **INSTR** to switch between multiple instrument windows.

Multiple instrument windows must first be configured as shown in Chapter 3.

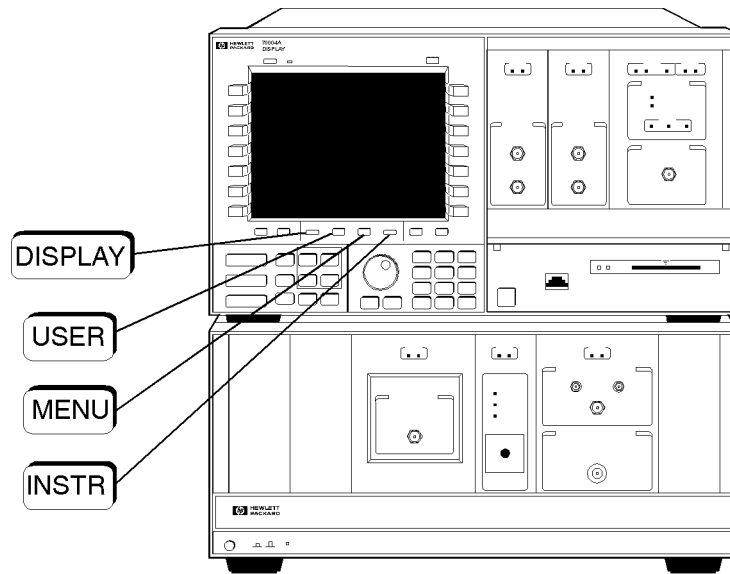

fig23

## Changing measurement parameters is easy

Use the front-panel knob, step keys, or numeric keypad to enter new measurements settings. For example, press the **CENTER** key to change the displayed center frequency. After changing the setting, pressing the **HOLD** key disables the keypad, knob, and step keys until another function is selected.

Use the **←** (backspace) key to speed your navigation through softkey menus. When pressed, the previous softkey menu is displayed. Also, use this key to backspace over numbers entered using the data-entry keypad.

## Conventions

The following key conventions are used in this guide:

- Front-panel key** Text shown like this represents a key physically located on the receiver.
- Softkey** Text shown like this represents a softkey. (The softkeys are located next to the softkey labels, and the softkey labels are the annotation on the right or left side of the spectrum analyzer display.)
- Screen Text** Text printed in this typeface indicates text displayed on the instrument's screen.



---

## Instrument Markings



The instruction documentation symbol. The product is marked with this symbol when it is necessary for the user to refer to the instructions in the documentation.

“CE” The CE mark is a registered trademark of the European Community. (If accompanied by a year, it is when the design was proven.)

“ISM1-A” This is a symbol of an Industrial Scientific and Medical Group 1 Class A product.

“CSA” The CSA mark is a registered trademark of the Canadian Standards Association.

---

### **CAUTION**

*Caution* denotes a hazard. It calls attention to a procedure that, if not correctly performed or adhered to, could result in damage to or destruction of the instrument. Do not proceed beyond a *caution* note until the indicated conditions are fully understood and met.

---

### **WARNING**

*Warning* denotes a hazard. It calls attention to a procedure which, if not correctly performed or adhered to, could result in injury or loss of life. Do not proceed beyond a *warning* note until the indicated conditions are fully understood and met.

---

---

**Assistance**

Product maintenance agreements and other customer assistance agreements are available for Hewlett-Packard products. For any assistance, contact your nearest Hewlett-Packard Sales and Service Office.

**Regulatory Information**

Regulatory information is located in Chapter 5, “Specifications and Characteristics.”

**Certification**

Hewlett-Packard Company certifies that this product met its published specifications at the time of shipment from the factory. Hewlett-Packard further certifies that its calibration measurements are traceable to the United States National Institute of Standards and Technology, to the extent allowed by the Institute’s calibration facility, and to the calibration facilities of other International Standards Organization members.

---

## Warranty

This Hewlett-Packard instrument product is warranted against defects in material and workmanship for a period of one year from date of shipment. During the warranty period, Hewlett-Packard Company will, at its option, either repair or replace products which prove to be defective.

For warranty service or repair, this product must be returned to a service facility designated by Hewlett-Packard. Buyer shall prepay shipping charges to Hewlett-Packard and Hewlett-Packard shall pay shipping charges to return the product to Buyer. However, Buyer shall pay all shipping charges, duties, and taxes for products returned to Hewlett-Packard from another country.

Hewlett-Packard warrants that its software and firmware designated by Hewlett-Packard for use with an instrument will execute its programming instructions when properly installed on that instrument. Hewlett-Packard does not warrant that the operation of the instrument, or software, or firmware will be uninterrupted or error-free.

### LIMITATION OF WARRANTY

The foregoing warranty shall not apply to defects resulting from improper or inadequate maintenance by Buyer, Buyer-supplied software or interfacing, unauthorized modification or misuse, operation outside of the environmental specifications for the product, or improper site preparation or maintenance.

NO OTHER WARRANTY IS EXPRESSED OR IMPLIED. HEWLETT-PACKARD SPECIFICALLY DISCLAIMS THE IMPLIED WARRANTIES OF MERCHANTABILITY AND FITNESS FOR A PARTICULAR PURPOSE.

### EXCLUSIVE REMEDIES

THE REMEDIES PROVIDED HEREIN ARE BUYER'S SOLE AND EXCLUSIVE REMEDIES. HEWLETT-PACKARD SHALL NOT BE LIABLE FOR ANY DIRECT, INDIRECT, SPECIAL, INCIDENTAL, OR CONSEQUENTIAL DAMAGES, WHETHER BASED ON CONTRACT, TORT, OR ANY OTHER LEGAL THEORY.



# Contents

---

<b>1. Getting Started</b>	
To install the receiver . . . . .	1-2
To install an Option 011 receiver . . . . .	1-12
To install an HP 70911A into an HP 71209A . . . . .	1-14
To install an HP 70620B preamp . . . . .	1-25
Maintaining the Receiver . . . . .	1-28
To clean the HP 70004A's screen . . . . .	1-28
To change the mainframe's fuse . . . . .	1-28
To change the custom keypad . . . . .	1-29
To locate a module's serial number . . . . .	1-30
Reinstalling the Receiver Personality . . . . .	1-31
To install from the memory card . . . . .	1-32
To install from a 3.5-inch diskette drive . . . . .	1-33
To install in an Option 011 instrument . . . . .	1-34
Returning the Receiver for Service . . . . .	1-35
To return a receiver for service . . . . .	1-35
<b>2. System Verification of Operation</b>	
<b>3. Operating</b>	
Calibrating the HP 71910A . . . . .	3-3
To perform a calibration . . . . .	3-3
To perform a calibration with HP 70620B preamp . . . . .	3-3
Searching for Signals (spectrum analyzer mode) . . . . .	3-4
Locating Signals . . . . .	3-5
To change the frequency range . . . . .	3-6
To return to full span . . . . .	3-7
To change the reference level and amplitude scale . . . . .	3-7
To change the amplitude units . . . . .	3-7
Using Markers . . . . .	3-8
To view a signal using markers . . . . .	3-8
Resolving Signals . . . . .	3-10
To resolve closely spaced signals . . . . .	3-10
Reducing Displayed Noise . . . . .	3-11
To reduce the displayed noise . . . . .	3-11
Controlling the Sweep . . . . .	3-12
To change the sweep time . . . . .	3-12
To set continuous or single sweeps . . . . .	3-12
Changing Center-Frequency Step Size . . . . .	3-13
To change the center frequency step size . . . . .	3-13
Collecting Signals (receiver mode) . . . . .	3-14
Changing to Receiver Mode . . . . .	3-16

To switch to receiver mode . . . . .	3-16
To select a new signal . . . . .	3-18
To return to spectrum analyzer mode . . . . .	3-18
Selecting IF Outputs and Channel Filters . . . . .	3-19
To select an IF output . . . . .	3-22
To adjust the IF and video bandwidth . . . . .	3-22
To change the IF-to-video bandwidth ratio . . . . .	3-22
To increase the 321.4 MHz bandwidth (preselector bypass) . . . . .	3-23
To adjust the IF gain and RF attenuation . . . . .	3-23
To select an Option 007 channel filter . . . . .	3-23
Demodulating Signals . . . . .	3-25
To demodulate the signal . . . . .	3-27
To adjust IQ gain, offset, and quadrature . . . . .	3-27
Viewing the Signal's Average Amplitude Level . . . . .	3-28
To view the average amplitude . . . . .	3-28
Measurement Examples . . . . .	3-29
To search for and collect a pulsed RF signal . . . . .	3-29
To characterize a wide-bandwidth FM signal . . . . .	3-34
To characterize a wide-bandwidth digital transmission . . . . .	3-38
Manually Collecting Signals . . . . .	3-41
Using Manual Mode . . . . .	3-43
To manually enter collection receiver mode . . . . .	3-45
To search for and collect a pulsed RF signal . . . . .	3-46
Using a Preamplifier . . . . .	3-49
To use the HP 70620B preamp . . . . .	3-50
To turn off the preamp in receiver mode . . . . .	3-50
Extending the Frequency Range with External Mixers . . . . .	3-51
Controlling System Configuration . . . . .	3-52
To save a receiver state . . . . .	3-53
To recall or delete a receiver state . . . . .	3-55
To view two instrument windows . . . . .	3-56
To blank the display . . . . .	3-56
To write a title on the screen . . . . .	3-57
Block Diagrams . . . . .	3-59
If You Have a Problem . . . . .	3-62
If UNCOR is displayed . . . . .	3-63
If UNCAL and Usable RBW limited is displayed . . . . .	3-64
If UNCAL and Usable VBW limited is displayed . . . . .	3-65
If Possible compression is displayed . . . . .	3-66
If the PREAMP On Off softkey doesn't work . . . . .	3-67
If there is a frequency shift in an HP 70911A output . . . . .	3-68

<b>4. Programming</b>	
Getting Started . . . . .	4-2
To connect the equipment . . . . .	4-3
HP BASIC Programming Example . . . . .	4-4
Communicating with the Receiver . . . . .	4-5
Initial Commands . . . . .	4-5
Executing Remote Commands . . . . .	4-5
Local and Remote Control . . . . .	4-6
Transferring Data to the Computer . . . . .	4-7
Monitoring System Operation . . . . .	4-8
Interrupt Process . . . . .	4-8
Receiver Status Byte . . . . .	4-8
The Service-Request Mask . . . . .	4-9
Monitoring System Operation without Using Service Requests . . . . .	4-10
<b>5. Specifications and Characteristics</b>	
Definitions of Terms . . . . .	5-2
HP 71910A Collection Receiver Specifications . . . . .	5-3
HP 71910A Search Receiver Specifications . . . . .	5-9
General Specifications . . . . .	5-15
Physical Dimensions of Mainframes . . . . .	5-16
Regulatory Information . . . . .	5-17
Notice for Germany: Noise Declaration . . . . .	5-18
<b>6. Menu Maps</b>	
<b>7. Dictionary Reference</b>	
Alphabetical Listing . . . . .	7-2
1.25 MHz . . . . .	7-2
5 MHz . . . . .	7-2
10 MHz . . . . .	7-2
20 MHz . . . . .	7-2
36 MHz . . . . .	7-2
70 MHz . . . . .	7-2
70 MHz OUT . . . . .	7-2
140 MHz OUT . . . . .	7-2
300 MHz IN . . . . .	7-3
300 MHz OUT . . . . .	7-3
321.4 MHz IN . . . . .	7-3
321.4 MHz OPT IN . . . . .	7-3
321.4 MHz OPT OUT . . . . .	7-3
321.4 MHz OUT . . . . .	7-3
70911 OPTIONS . . . . .	7-3
← . . . . .	7-3
▲ ▼ . . . . .	7-4
△ . . . . .	7-4
A UNITS AutoMan . . . . .	7-4
AM . . . . .	7-4
BYPASS . . . . .	7-4

BW	7-4
<b>CENTER</b>	7-4
CENTER	7-5
CF STEP AutoMan	7-5
channel filters	7-5
dBm	7-5
dBmV	7-5
dBuV	7-5
DEL RX STATE	7-5
Demod	7-5
DISPLAY On Off	7-6
FM	7-6
FM NB	7-6
FM WB	7-6
Freq	7-6
FULL SPAN	7-6
Gain	7-7
Help On Off	7-7
<b>HOLD</b>	7-7
HP-MSIB CARD	7-7
HPIB DISK	7-7
I	7-8
I GAIN	7-8
I OFFSET	7-8
IF BW	7-8
IF GAIN AutoMan	7-9
<b>INSTR</b>	7-9
<b>INSTR PRESET</b>	7-9
INTRNL MEMORY	7-10
IQ	7-10
LAST STATE	7-10
<b>MENU</b>	7-10
Misc	7-10
NARROW SPAN	7-10
NB VID IN	7-10
<b>NEXT PEAK</b>	7-11
<b>NORMAL</b>	7-11
<b>PEAK SEARCH</b>	7-11
<b>PLOT</b>	7-11
PREAMP On Off	7-11
PRESEL On Off	7-11
<b>PRINT</b>	7-12
PULSE	7-12



Q . . . . .	7-12
Q GAIN . . . . .	7-12
Q OFFSET . . . . .	7-13
QUADRATURE . . . . .	7-13
RCL RX STATE . . . . .	7-13
RECALL . . . . .	7-13
RECEIVR VERSION . . . . .	7-14
REF LEVEL . . . . .	7-14
Return to S/A . . . . .	7-14
RF ATTN AutoMan . . . . .	7-14
RF/IF Gain: . . . . .	7-14
save & recall . . . . .	7-15
SAVE RX STATE . . . . .	7-15
SIG LVL On Off . . . . .	7-15
SIGNAL TRACK . . . . .	7-16
SPAN . . . . .	7-16
SPAN . . . . .	7-16
START FREQ . . . . .	7-16
STOP FREQ . . . . .	7-16
temp compens . . . . .	7-16
TITLE . . . . .	7-17
units menu . . . . .	7-17
USER . . . . .	7-17
VBW/IFB RATIO . . . . .	7-17
VID BW AutoMan . . . . .	7-17
VID OUT TO L.O. . . . .	7-17
VIDEO . . . . .	7-17
VOLT . . . . .	7-18
WATT . . . . .	7-18
WB VID IN . . . . .	7-18
WB VID OUT . . . . .	7-18

## 8. Programming Commands

Syntax Conventions . . . . .	8-2
Softkeys Versus Commands . . . . .	8-4
RXRMT CHANFILT . . . . .	8-6
RXRMT CHANPATH . . . . .	8-8
RXRMT DELETERX . . . . .	8-10
RXRMT DEMOD . . . . .	8-11
RXRMT FMOFF . . . . .	8-13
RXRMT IFGAIN . . . . .	8-15
RXRMT IGAIN . . . . .	8-16
RXRMT INIT . . . . .	8-17
RXRMT IOFFSET . . . . .	8-18
RXRMT OPTIONS? . . . . .	8-19
RXRMT QGAIN . . . . .	8-20

RXRMT QOFFSET . . . . .	8-21
RXRMT QUAD . . . . .	8-22
RXRMT RECALLRX . . . . .	8-24
RXRMT SAVERX . . . . .	8-25
RXRMT TEMPCOMP . . . . .	8-26
RXRMT VERSION? . . . . .	8-27
<b>9. Error Messages</b>	
Error Message Descriptions . . . . .	9-2
Troubleshooting Features . . . . .	9-6
<b>10. Tables and Charts</b>	
<b>11. Configuring and Addressing</b>	
Modular Measurement System Terms . . . . .	11-2
Functional Terms . . . . .	11-2
Element . . . . .	11-2
Master . . . . .	11-2
Sub-master . . . . .	11-2
Slave . . . . .	11-2
Independent element . . . . .	11-2
Instrument . . . . .	11-2
Structural Terms . . . . .	11-2
Mainframe . . . . .	11-2
Module . . . . .	11-2
Stand-Alone Instrument . . . . .	11-3
Address Map Protocol . . . . .	11-4
Address Matrix . . . . .	11-4
Display-Response Area . . . . .	11-5
HP-IB Access . . . . .	11-5
Addressing Elements . . . . .	11-6
Master Elements . . . . .	11-6
Sub-Master Elements . . . . .	11-6
Slave Elements . . . . .	11-7
Slave Area Boundaries . . . . .	11-7
Independent Elements . . . . .	11-8
Addressing Order Requirements . . . . .	11-9
Default Addressing for Configured HP 70000 Systems . . . . .	11-9
Addressing Criteria . . . . .	11-9
HP 70900B local oscillator source . . . . .	11-9
HP 70902A IF section . . . . .	11-9
HP 70700A digitizer . . . . .	11-10
HP 70911A ultra-wide bandwidth IF section . . . . .	11-10
HP 70903A IF section . . . . .	11-10
HP 70907B . . . . .	11-10
RF section . . . . .	11-10
HP 70600A preselector/HP 70601A preselector . . . . .	11-10
HP 70300A RF tracking generator . . . . .	11-10
HP 70301A microwave tracking generator . . . . .	11-10
HP 70310A precision frequency reference . . . . .	11-10
HP 70621A or HP 70620B preamplifiers . . . . .	11-10

Row Addressing Priority . . . . .	11-11
Address Switches . . . . .	11-12
Master Address Switches . . . . .	11-12
HP-IB ON/OFF . . . . .	11-13
SW1/MEM . . . . .	11-13
MAS/SLA . . . . .	11-13
NRML/TEST . . . . .	11-13
COLUMNS 1—5 . . . . .	11-13
ROWS 1—3 . . . . .	11-13
Slave Address Switches . . . . .	11-14
Rows 1—3 . . . . .	11-14
Columns 1—5 . . . . .	11-14
Display Address Switches . . . . .	11-14
HP-IB ON/OFF . . . . .	11-14
A1—A5 . . . . .	11-14
TALK ONLY . . . . .	11-15
SYSTEM CONTROLLER . . . . .	11-15
TEST MODE . . . . .	11-15

**Index**

## Tables

---

10-1. Hewlett-Packard Sales and Service Offices . . . . .	10-4
---	------

## Getting Started

---

This chapter shows you how to install and maintain the HP 71910A and its various options. In addition, there is a procedure for installing an HP 70911A wide bandwidth IF module into an existing HP 71209A Option 001 spectrum analyzer.

No special tools are required except for the procedure “To install an HP 70911A in your HP 71209A.” This procedure requires an 8 mm ball driver. Be careful to observe all notes, cautions, and warnings in the procedures.

### Contents

To install the receiver .....	1-2
To install an Option 011 receiver .....	1-12
To install an HP 70911A into an HP 71209A .....	1-14
To install an HP 70620B preamp .....	1-25
Maintaining the Receiver .....	1-28
To clean the HP 70004A's screen .....	1-28
To change the mainframe's fuse .....	1-28
To change the custom keypad .....	1-29
To locate a module's serial number .....	1-30
Reinstalling the Receiver Personality .....	1-31
To install from the memory card .....	1-32
To install from a 3.5-inch diskette drive .....	1-33
To install in an Option 011 instrument .....	1-34
Returning the Receiver for Service .....	1-35
To return a receiver for service .....	1-35

### Note

The following installation procedure applies to both the HP 71910A wide bandwidth surveillance receiver and the HP 71910P wide bandwidth surveillance receiver. In a “P” system, the HP 70207A PC Display for MMS replaces the HP 70004A color display.

There are no specification changes between the “P” and “A” systems, only module placement and rear-panel cabling are different.

Refer to the *HP 70207A User's Guide* for complete installation instructions of the HP 70207A PC Display for MMS, the MSIB interface card, and the MSIB Y-cable that is used with a “P” system.

---

---

## To install the receiver

1. Inspect the shipping container or cushioning material for damage.

If there is damage or a defect, save the packing materials, file a claim with the carrier, then contact the nearest Hewlett-Packard sales and service office for immediate repair or replacement.

2. Make sure the instrument's line-voltage selectors are set to the same voltage as the power source.

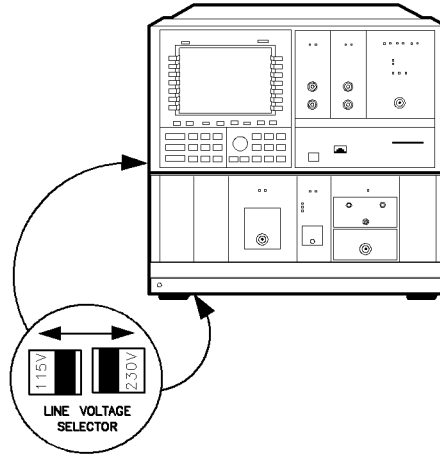

fig 9

---

**CAUTION** Before turning the instrument on, be sure the **LINE VOLTAGE SELECTOR** is set to the correct voltage for the power source. Failure to do this may cause damage (a blown fuse) to the system when the power cable is plugged in.

---

**Note** Option 400 instruments for 400 Hz operation come with an external in-line isolation transformer for use with the HP 70001A mainframe. The isolation transformer protects the user from shock hazard. The in-line isolation transformer must be removed for 60 Hz power-source operation. Failure to remove the in-line transformer may result in a blown fuse. The HP 70004A display/mainframe does not require an option to operate on 400 Hz.

---

**WARNING** Do not operate a 400 Hz option receiver on a 400 Hz power line without the attached in-line isolation transformer for the HP 70001A mainframe. Failure to follow this precaution can result in personal injury.

---

- If you're installing a standard HP 71910A, connect the rear-panel cables as shown in the following figure:

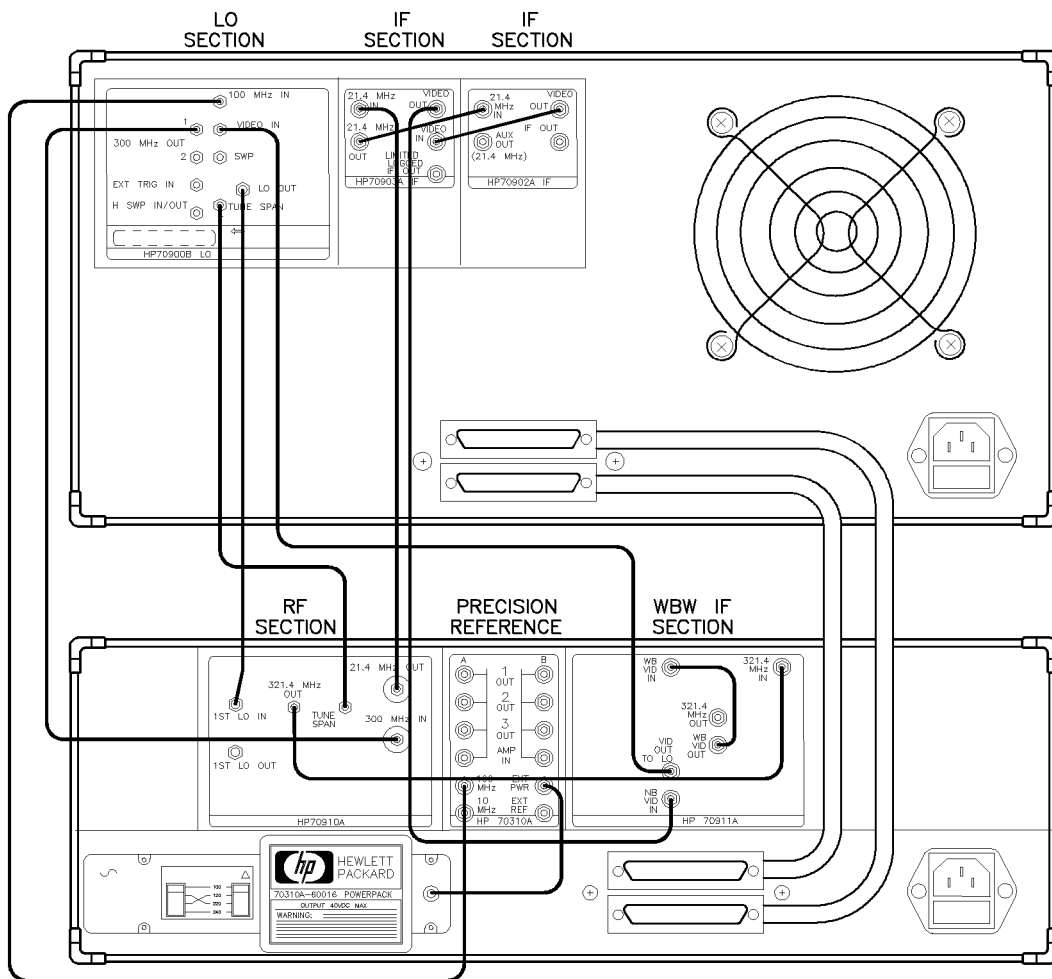

wbw1

**Rear-Panel Connections for the Standard HP 71910A**

- If you're installing an HP 71910A that has an option, connect the rear-panel cables as shown in the following figure:

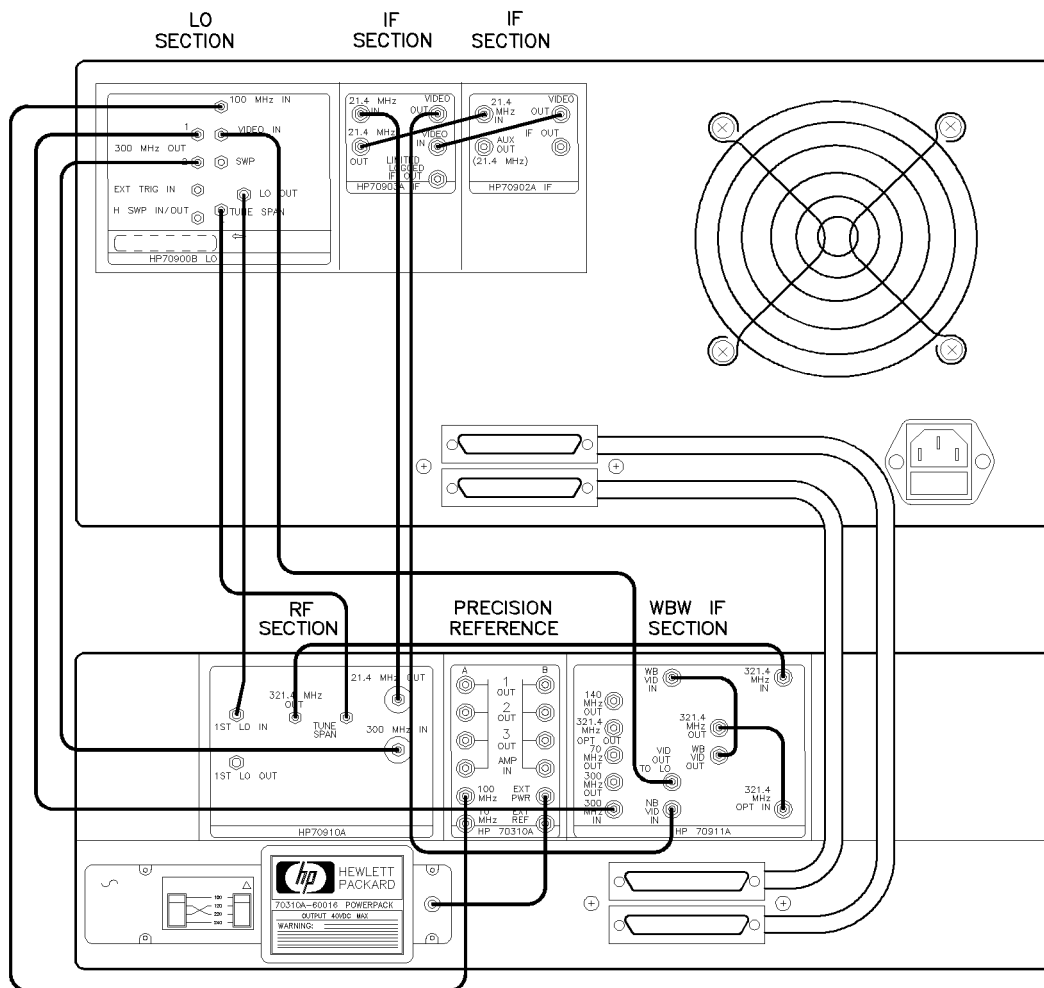

wbw2

**Rear-Panel Connections for the HP 71910A with Options**



- If you're installing a standard HP 71910P, connect the rear-panel cables as shown in the following figure:

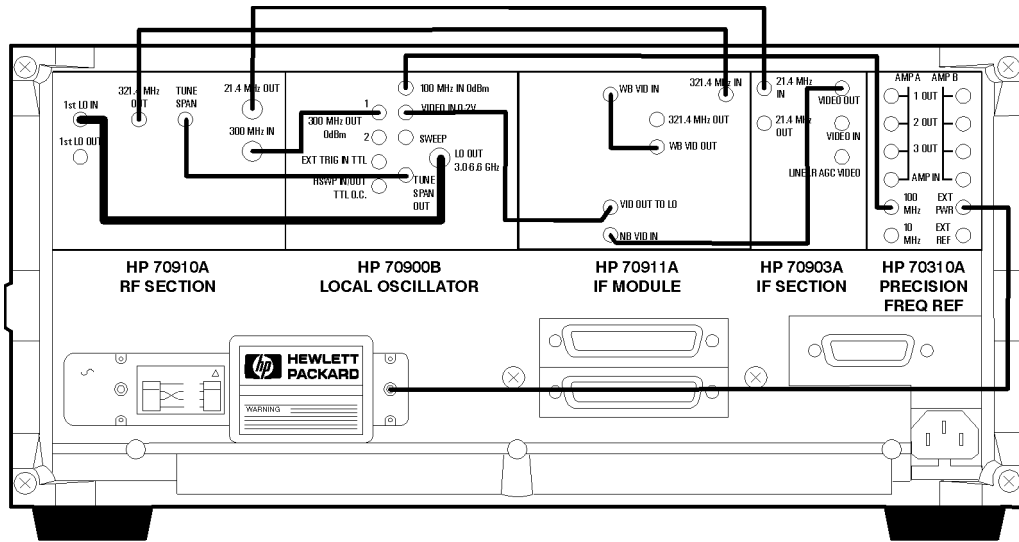

poonfg16.cdr

**Rear-Panel Connections for the Standard HP 71910P**

6. If you're installing a standard HP 71910P with two mainframes and an HP 70902A IF section added, connect the rear-panel cables as shown in the following figure:

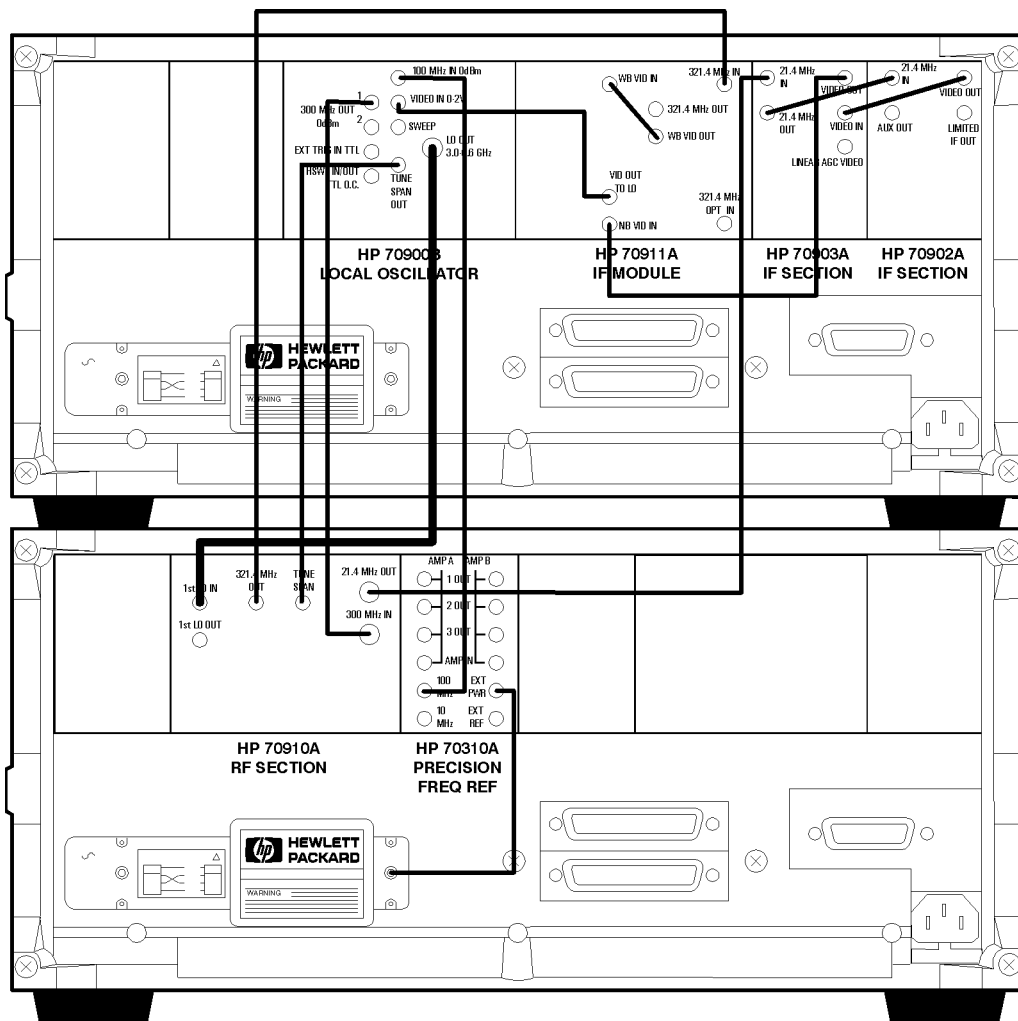

poonfg17.cdr

**Rear-Panel Connections for the Standard HP 71910P with Two Mainframes and an HP 70902A IF Section Added**

7. If you're installing a standard HP 71910P with two mainframes and an HP 70620B preamplifier added, connect the rear-panel cables as shown in the following figure:

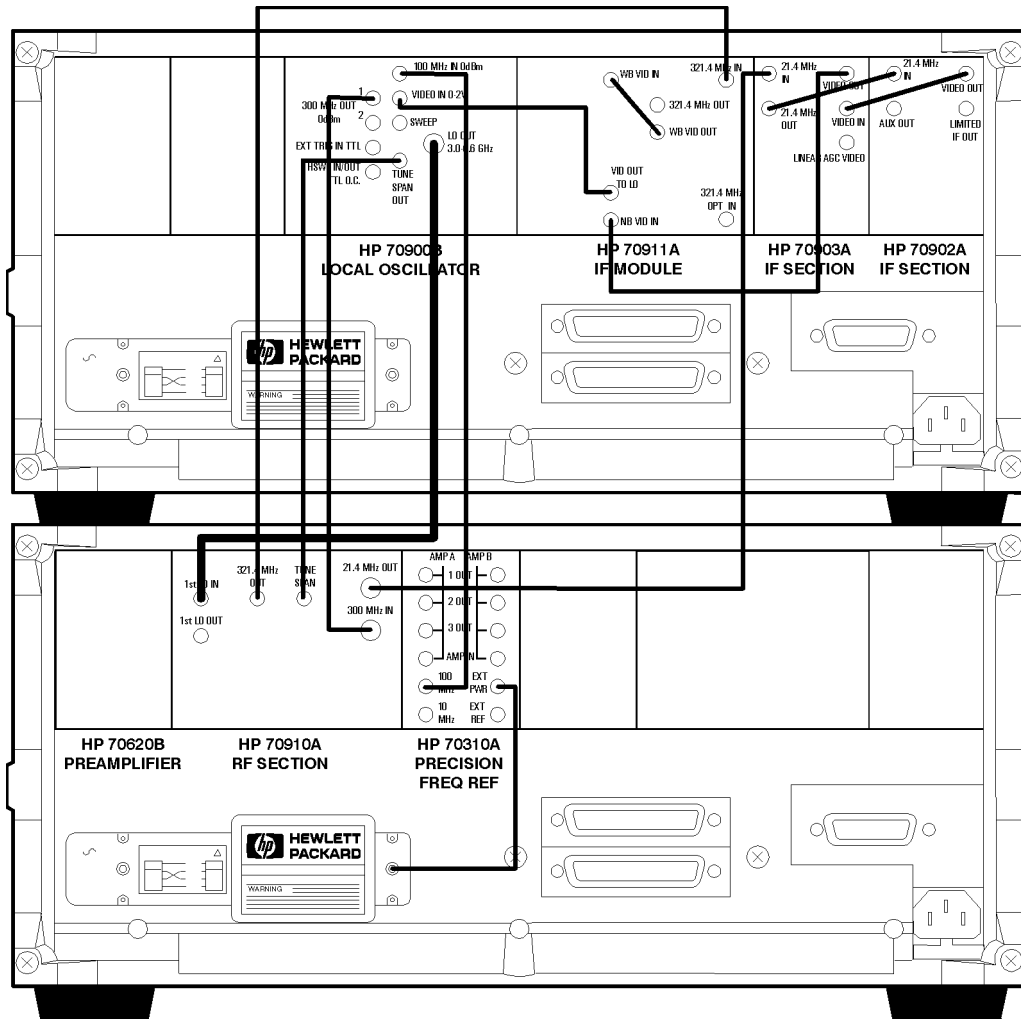

pconfg18.cdr

**Rear-Panel Connections for the Standard HP 71910P with Two Mainframes and an HP 70620B Preamplifier Added**

8. If you're connecting the MSIB cables on an HP 71910A, connect the MSIB cables as shown in the following figure:

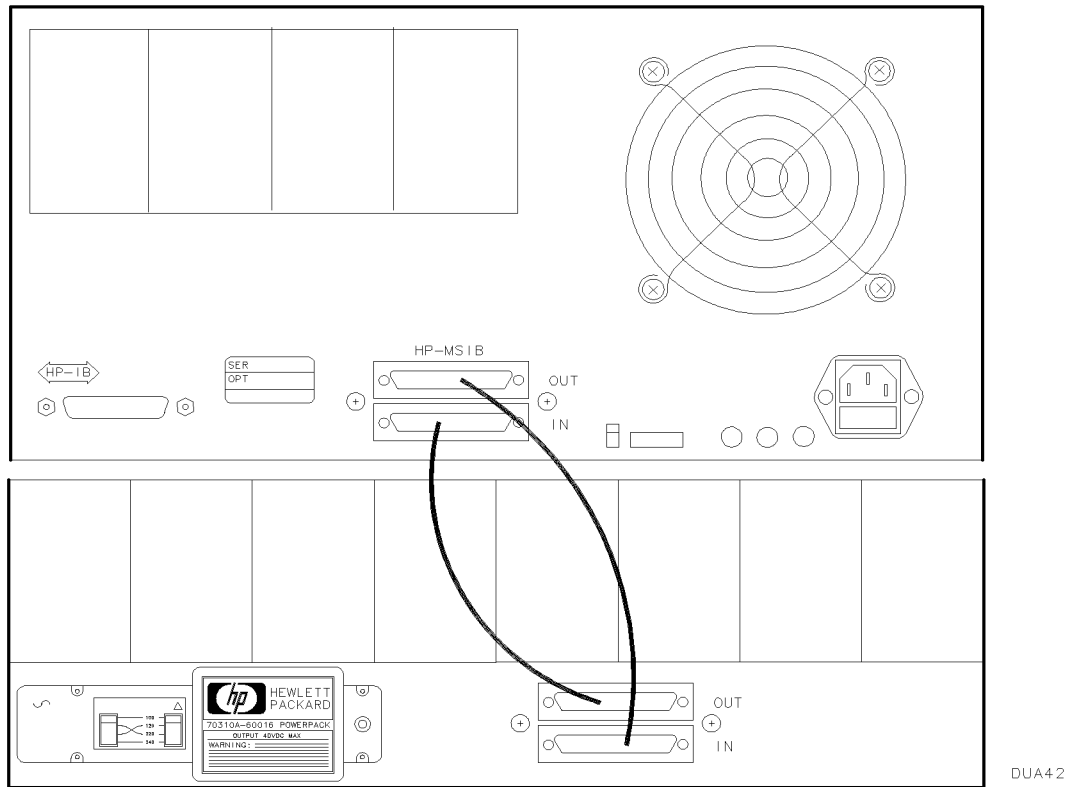

#### MSIB Cabling from the HP 70001A Mainframe to the HP 70004A Color Display

- Connect an MSIB cable between the HP 70004A color display's MSIB OUT connector and the HP 70001A mainframe's MSIB IN connector.
- Connect an MSIB cable between the HP 70001A mainframe's MSIB OUT connector and the HP 70004A color display's MSIB IN connector.

The MSIB cables are connected serially, coupling the input of one element to the output of the next until the loop is completed.

9. If you're connecting the MSIB Y-Cable on an HP 71910P, connect the cables as shown in the following figure:

---

**CAUTION** Care should be taken when connecting the MSIB Y-cable to the MSIB interface card. Damage can occur if the MSIB Y-cable connection is not properly aligned. Ensure power is not applied while making or removing connections.

---

- a. Remove the protective cap from the MSIB Y-cable and inspect the pins for damage or misalignment. **Do not install MSIB Y-cable if pins are bent or damaged.** If necessary, obtain service from Hewlett-Packard. Refer to "Returning the Receiver for Service".
  - b. Align the MSIB Y-cable to the MSIB interface card's MSIB connector (1).  
**Do not force the connectors together!** (See the above caution.)
  - c. Tighten the captive-screws on the MSIB Y-cable to the MSIB interface card.  
**Do not over tighten the screws!**
  - d. Connect the two free-ends of the MSIB Y-cable (that are not connected to the MSIB interface card) to the HP 70001A mainframe's IN and OUT MSIB connectors (2).
- The MSIB cables are connected serially, coupling the input of one HP 70001A mainframe to the output of the next until a loop is completed.
- e. Connect the ac line cord to your computer and display.

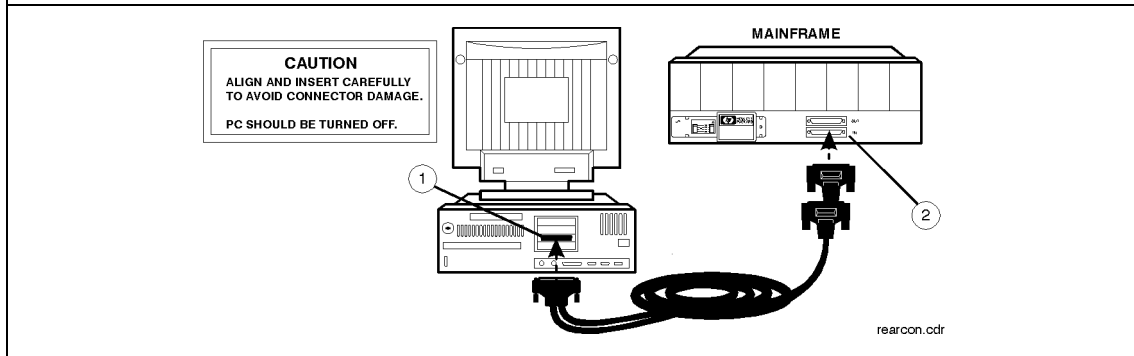

---

**Note** Refer to the *HP 70207A User's Guide* for complete installation instructions of the HP 70207A PC Display for MMS, the MSIB interface card, and the MSIB Y-cable.

---

10. Connect the power cables to both instrument mainframes first, then plug the cables into the power outlet.

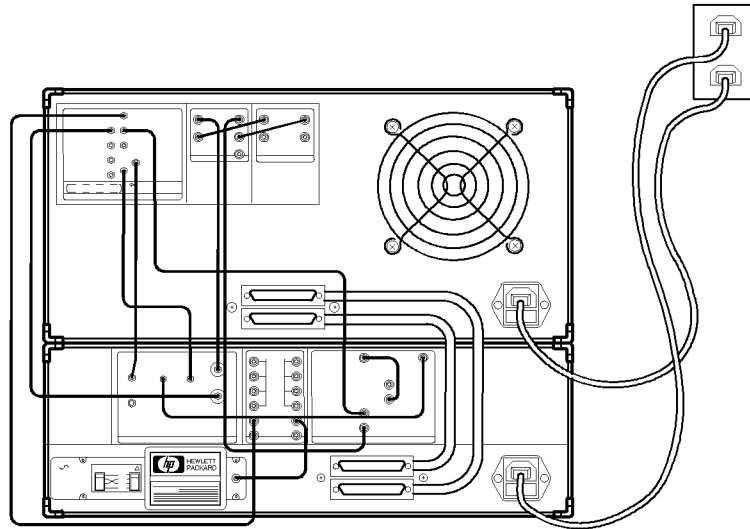

fig10.

11. Set the HP 70001A mainframe's  LINE switch to ON, and listen to verify that the ventilation fan starts up.
12. If an HP 70004A color display is being used in your system (such as the HP 71910A), set the  LINE switch to ON, and listen to verify that the ventilation fan starts up.

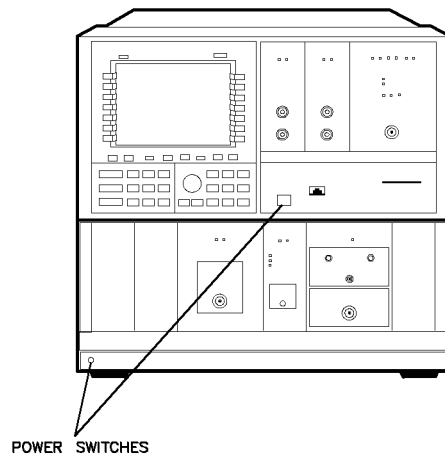
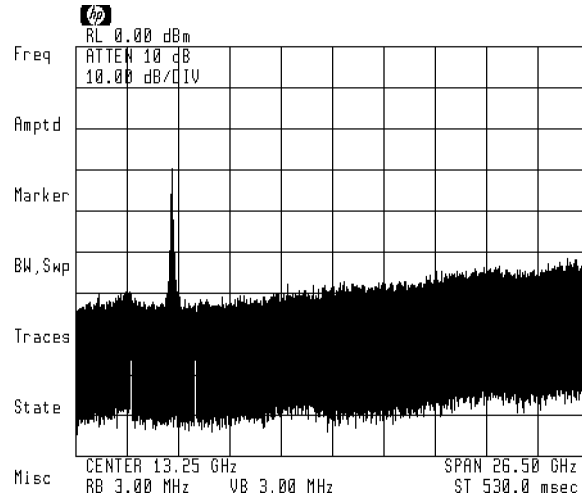

fig15

13. Except on the IF sections, each module's front-panel ACT LED should be lit. Only one of the IF sections will have its ACT light on.
14. On the display, the left-side softkeys shown in the following figure should be displayed.

## 1-10 Getting Started



If the receiver menu softkeys do not appear after power-up, the display window probably is not assigned to the receiver. To assign it, perform the following steps:

- a. Press the **DISPLAY** key on the display's front panel to access the main menu for the display.
- b. Press the **NEXT INSTR** softkey until the receiver is selected for independent operation.
- c. Press the **MENU** key to display the seven softkeys for stand-alone operation of the receiver.

## To install an Option 011 receiver

1. Inspect the shipping container or cushioning material for damage.

If there is damage or a defect, save the packing materials, file a claim with the carrier, then contact the nearest Hewlett-Packard sales and service office for immediate repair or replacement.

2. Connect the rear-panel cables as shown in one of the following two figures:

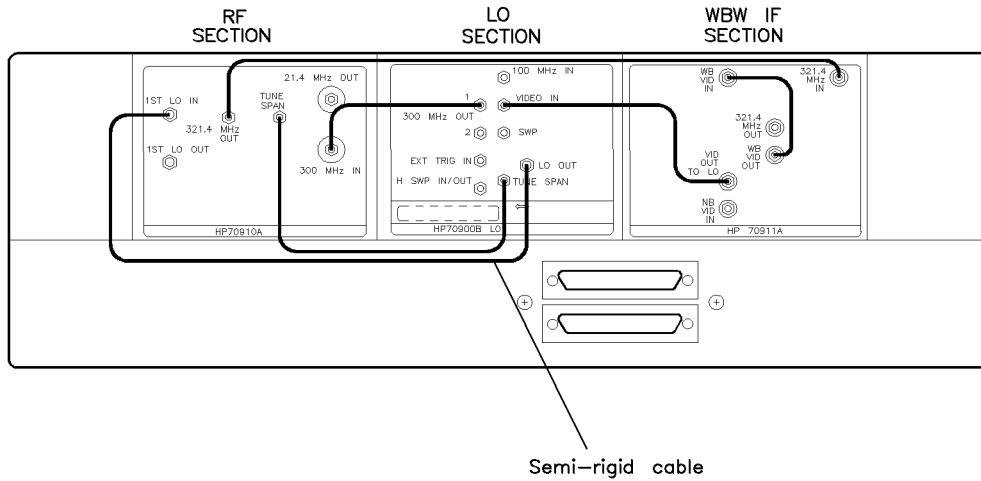

wbw3

### Standard Rear-Panel Connections

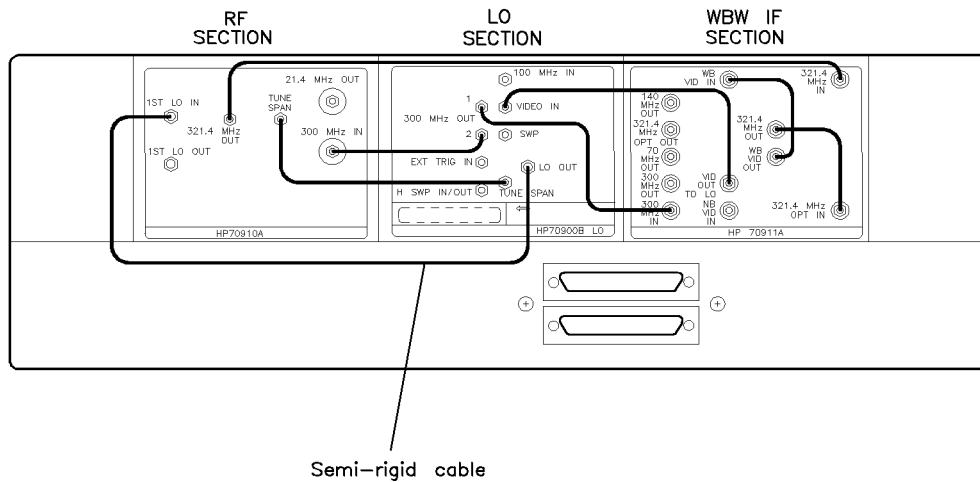

wbw4

### Rear-Panel Connections for Receiver with Options

3. Make sure the HP 70001A mainframe's line-voltage selector is set to the same voltage as the power source.



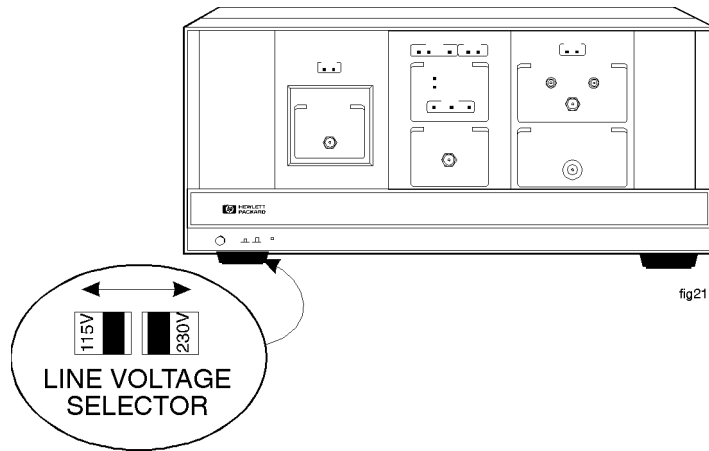

---

**CAUTION** Before turning the instrument on, be sure the **LINE VOLTAGE SELECTOR** is set to the correct voltage for the power source. Failure to do this may cause damage (a blown fuse) to the system when the power cable is plugged in.

---

**Note** Option 400 instruments for 400 Hz operation come with an external in-line isolation transformer for use with the HP 70001A mainframe. The isolation transformer protects the user from shock hazard. The in-line isolation transformer must be removed for 60 Hz power-source operation. Failure to remove the in-line transformer may result in a blown fuse.

---

**WARNING** Do not operate a 400 Hz option receiver on a 400 Hz power line without the attached in-line isolation transformer for the HP 70001A mainframe. Failure to follow this precaution can result in personal injury.

---

4. Connect the power cable to the HP 70001A mainframe first, then plug the cable into the power outlet.
5. Set the HP 70001A mainframe's  **LINE** switch to ON, and listen to verify that the ventilation fan starts up.
6. Check to see that each module's front-panel ACT LED lights.

---

## To install an HP 70911A into an HP 71209A

This procedure shows you how to install an HP 70911A module into an already existing HP 71209A Option 001 spectrum analyzer. Option 001 spectrum analyzers have an HP 70910A wide-bandwidth RF module instead of the standard HP 70909A RF module.

Older HP 71209A Option 001 spectrum analyzers may need to be modified before you can install the HP 70911A ultra-wide bandwidth section which includes options. This is explained in the following paragraphs.

### HP 70001A mainframe upgrade

If the HP 70001A mainframe has a serial number of 3327A05741 or earlier, an upgrade kit must be installed that increases the power and airflow capability. The serial number is located by opening the HP 70001A's front-panel door to expose the hex-lock screws that are used for installing modules. The serial number label is located behind this door on the inside of the right frame section.

---

**WARNING** In order to provide proper cooling for the HP 70911A module which includes options, the HP 70001A mainframe must have a serial number higher than 3327A05741. If the HP 70001A serial number is 3327A05741 or below, contact your local Hewlett-Packard sales and service office for information on installing an upgrade kit. HP 70911A modules that do not include option cards will not require the retrofit kit.

---

### HP 70900B LO upgrade

The HP 70900B local oscillator module must have firmware 940120 or later and include the 1 MByte memory option. To view the firmware date code, do the following steps:

1. Press **MENU**.
2. Press the left-side **Misc** softkey.
3. Press **MORE 1 of 3** and then **service**.
4. Press **ROM VERSION**.

When upgrading an existing HP 71209A Option 001, order the HP 70911A Option 099 or 098 to obtain the LO firmware and memory upgrade. An HP 71910A system already includes these items. To determine which option (098 or 099) is required, do the following steps:

1. Press **MENU**.
2. Press the left-side **State** softkey.
3. Press **MORE 1 of 4**, **MORE 2 of 4**, and then **show states**.
4. Press **EXTEND STATE**.
5. Find the CPU: heading that is displayed on the screen.
6. If the entry reads 68000, the HP 70911A Option 098 is required. If the entry reads 68020, the HP 70911A Option 099 is required.

## HP 70910A RF section upgrade

The HP 71910A includes an HP 70910A RF section with firmware enhancements for moderately faster tuning than older HP 70910A RF sections. HP 70910A's with serial number 3409A00170 and later include this newer firmware. The newer firmware is not necessary for proper operation. Contact an HP service center for upgrade information.

### Tools needed

Install the module requires one of the following drivers:

- 8 mm hex-ball driver (*long*) .....HP part number 8710-1307
- 8 mm hex-ball driver (*short*) .....HP part number 8710-1651

### Antistatic precautions

Electrical components are easily damaged by small amounts of static electricity. If possible, work at a static-free work station.

### Procedure

1. Inspect the shipping container or cushioning material for damage.
  - If there is damage or a defect, save the packing materials, file a claim with the carrier, then contact the nearest Hewlett-Packard sales and service office for immediate repair or replacement.
2. Turn on your HP 71209A Option 001 spectrum analyzer.
3. Press **DISPLAY** and then the left-side **Address Map** softkey.
4. Turn the front-panel knob to scroll the address map so that the modules are shown. The address map should look like the one displayed in the following figure.

		70310A FREQ REF	
	70910A RF SECT		
R O W	70903A IF SECT		
	70902A IF SECT		
	70900A LO/CTLR HP-IB18		
	17	18	19
	COLUMN		

DUA57

**Address Map of HP 71209A**

The HP 70911A has a default MMS address of 3,18 which places it between the HP 70903A and HP 70902A modules in the above figure. If this space is unavailable, you may need to change the address of the HP 70911A. For a general discussion of MMS addressing, refer to Chapter 11. The following figure shows the address switches

on the HP 70911A module. The switches are set to the default MMS address of ROW 3 and COLUMN 18.

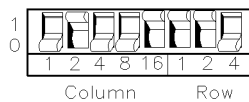

switch2

5. Turn off the ac line power to the HP 71209A, and remove the two line-power cords from the mainframes.

6. Open the HP 70001A mainframe's front-panel door to expose the hex-lock screw.

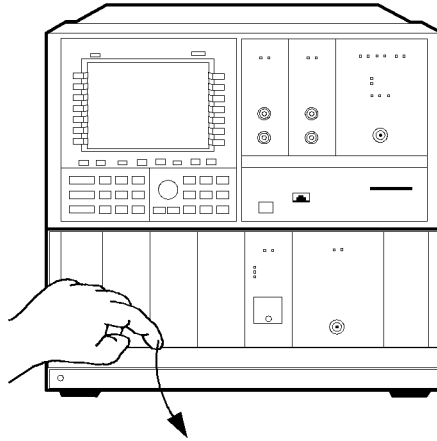

fig5

7. Using an 8 mm hex-ball driver, turn the hex-lock bolts counterclockwise to unlock and remove the two blank panels shown in the following figure.

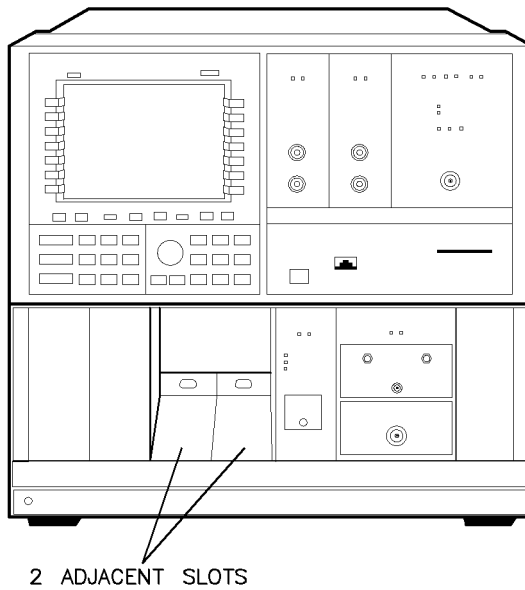

fig7

8. Install the new HP 70911A module next to the HP 70310A.

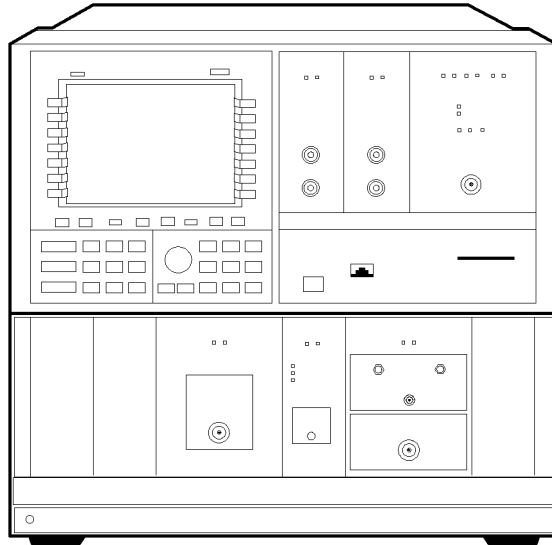
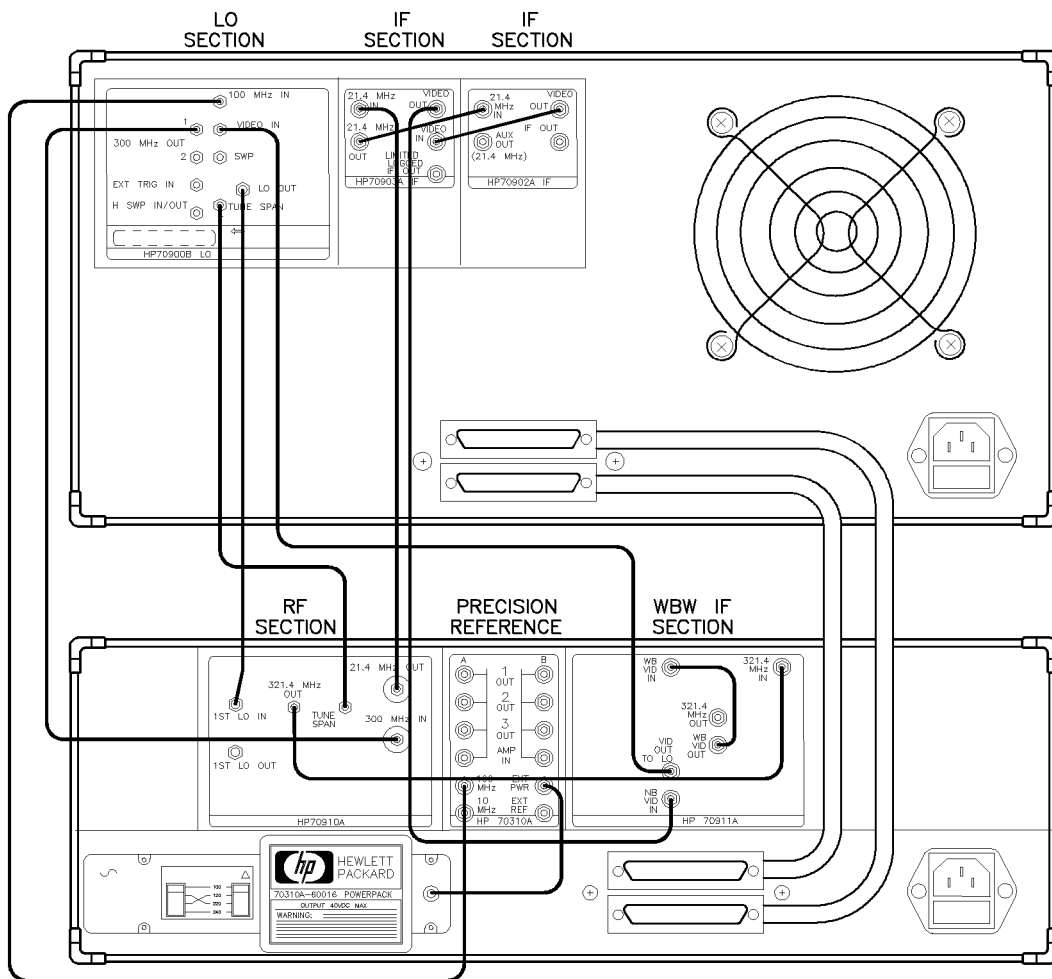

fig14

9. If you're installing a standard HP 70911A module, connect the rear-panel cables as shown in the following figure.



wbw1

### Rear-Panel Connections for Standard Configuration

**Note**

If you have an HP 71910P configuration, refer to the section, “To install the receiver”, which is located at the beginning of this chapter.

- If you're installing an Option 001/002 HP 70911A module, connect the rear-panel cables as shown in the following figure.

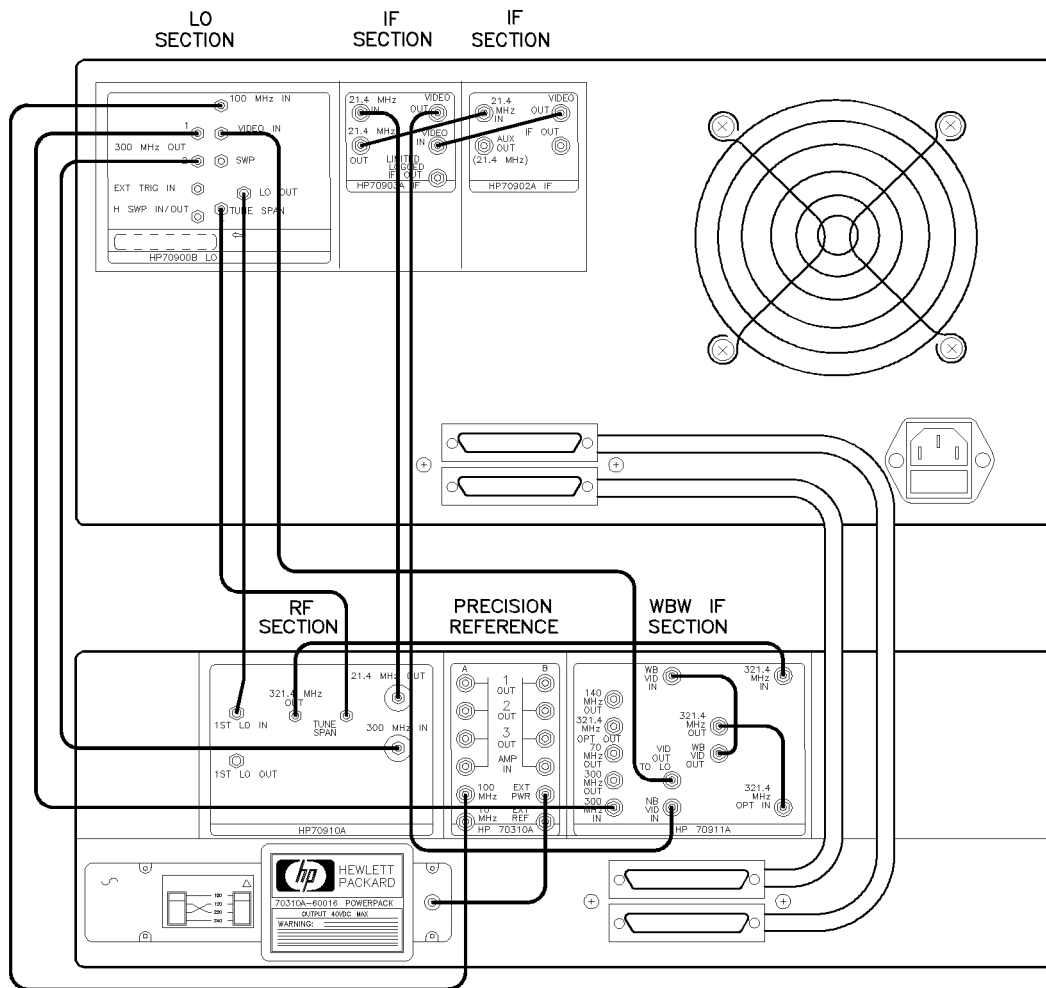

wbw2

**Rear-Panel Connections for Option 001/002**



11. Connect the power cables to both instrument mainframes first, then plug the cables into the power outlet.

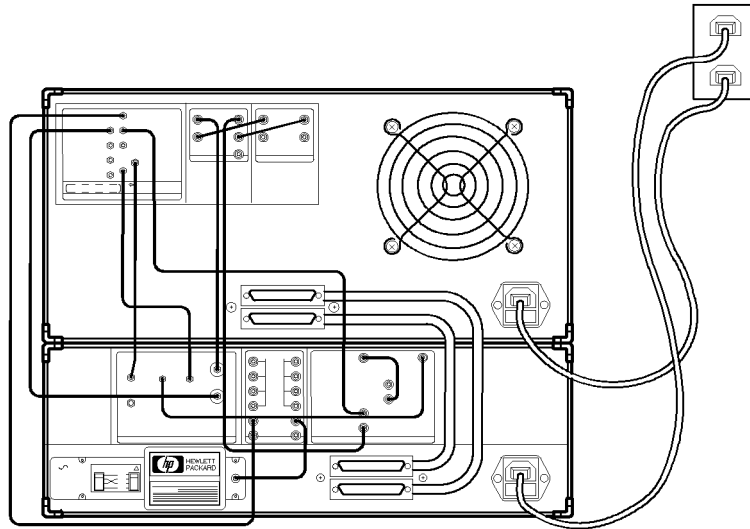

fig10

12. Set the HP 70001A mainframe's  LINE switch to ON, and listen to verify that the ventilation fan starts up.
13. If an HP 70004A color display is being used in your system (such as the HP 71910A), set the  LINE switch to ON, and listen to verify that the ventilation fan starts up.
14. Check to see that each module's front-panel ACT LED lights. When two IF sections are in the system, only the one that is selected will have its ACT light on.
15. If an ERR LED remains on, check the address map as described in the following steps.
  - a. Press **DISPLAY**.
  - b. Press the left-side **Address Map** softkey.
  - c. Turn the front-panel knob to scroll the address map so that it looks similar the one shown in the following figure. Make sure that the order of the modules is such that the ROW addresses (highest to lowest) are as shown in the following figure. For example, the HP 70911A must be "above" the HP 70902A and "below" the HP 70903A. The location of the empty ROW addresses is not important.

**hp**

7		70310A P.F.R.	
6	70910A RF SECT		
5			
4	70903A IF SECT		
3	70911A IF SECT		
2			
1	70902A IF SECT		
0	70900B Lo/Ctrlr HP-1B 1B		
	17	18	19

COLUMN

**Example of a Correct Address Map**

16. Press the **DISPLAY** key on the display's front panel to access the main menu for the display.
17. Press the **NEXT INSTR** softkey until the left-side softkeys shown in the following figure are displayed.

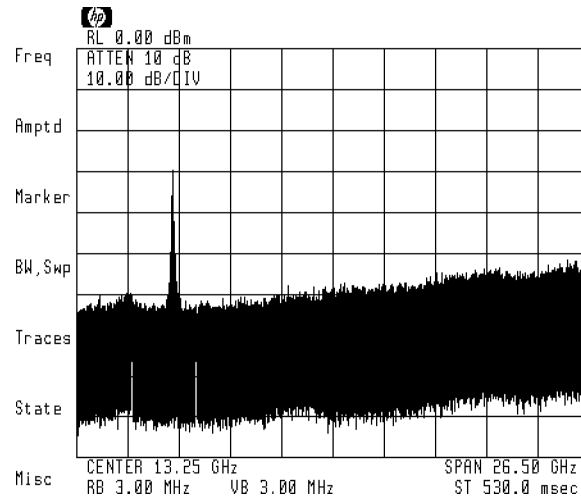

18. Press the **MENU** key to display the seven softkeys for stand-alone operation of the receiver.
19. Locate the memory card containing the receiver personality.
20. Locate the arrow printed on one end of the card.

21. Insert the card into the HP 70004A display's front-panel card slot. Match the card's arrow with the arrow printed above the card slot.

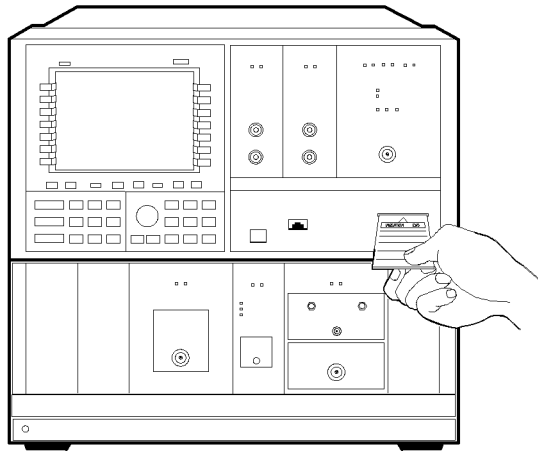

insert

22. Press **MENU** and then the left-side **Misc** softkey.
23. Press **MORE 1 of 3** and then **catalog & MSI**.
24. Press **HP-MSIB CARD** to display all files contained on the memory card.

If 2053 Storage device error is displayed, either the card is missing, the card's write-protect switch is in the SAFE position, or the card's HP-MSIB address is listed incorrectly. The HP-MSIB address for the card is the same address as the display's HP-IB address and is normally set to 4. If the address is not correct, enter the correct address using the numeric keypad.

25. Press **LOAD FILE**, and enter 1 for the file number.
26. Press **ENTER**.

The front-panel LED next to the card slot lights indicating that the files are being copied into the **USER** menu. This process takes approximately 60 seconds.

27. Press **USER** and then **RX\_MODE** to start the receiver personality.
28. The left-side softkeys, shown in the following figure, should be visible.

```

Receiver Mode
Freq: 5.001988 GHz
IF BW: 10 MHz
RF/IF Gain: 0 dB
IF Gain: 10 dB
RF Atten: 10 dB
Sig Lvl (avg): Off
Demod: AM
Misc
Help
On Off
Return to S/A
Ampl vs Time

```

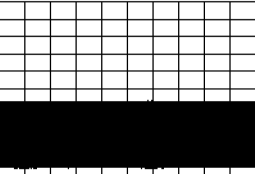

---

## To install an HP 70620B preamp

### Tools needed

Install the module requires one of the following drivers:

- 8 mm hex-ball driver (*long*) .....HP part number 8710-1307
- 8 mm hex-ball driver (*short*) .....HP part number 8710-1651

### Procedure

1. Turn on your HP 71910A receiver.
2. Press **DISPLAY** and then the left-side **Address Map** softkey.
3. Turn the front-panel knob to scroll the address map so that the modules are shown. The address map should look like the one displayed in the following figure.



7			70310A P.F.R.	
6		70910A RF SECT		
5				
4		70903A IF SECT		
3		70911A IF SECT		
2				
1		70902A IF SECT		
0		70900B Lo/Ctrlr HP-IB 1B		
	17	18	19	20

COLUMN

**Address Map of HP 71910A**

4. Locate the HP 70620B preamplifier's address switch. Make sure that the switches are set to a value of **ROW 6** and **COLUMN 19**. This will position the HP 70620B below any HP 70310A precision frequency reference that might be present.
5. Turn off the ac line power to the HP 71209A, and remove the two line-power cords from the mainframes.

6. Open the HP 70001A mainframe's front-panel door to expose the hex-lock screw.
7. Using an 8 mm hex-ball driver, turn the hex-lock bolt to remove the blank panel that is located to the right of the HP 70910A RF section.
8. Install the HP 70620B in the empty slot.
9. Connect a cable between the HP 70620B's front-panel RF INPUT connector and the HP 70910A's front-pane RF OUTPUT connector.
10. Set the HP 70001A mainframe's  LINE switch to ON.
11. Set the HP 70004A mainframe's  LINE switch to ON.
12. If an ERR LED remains on, check the address map as described in the following steps.
  - a. Press **DISPLAY**.
  - b. Press the left-side **Address Map** softkey.
  - c. Turn the front-panel knob to scroll the address map so that it looks similar the one shown in the following figure. Your receiver may not have an HP 70310A precision frequency reference. Make sure that the order of the modules is such that the ROW addresses (highest to lowest) are as shown in the following figure. The location of the empty ROW addresses is not important.



Freq	7			70310A P.F.R.	
Amptd	6		70910A RF SECT	70620B PREAMP	
	5				
Marker	4		70903A IF SECT		
ROW	3		70911A IF SECT		
BW, SWP	2				
Traces	1		70902A IF SECT		
State	0		70900B Lo/Ct 1r HP-1B 1B		
Misc					
		17	18	19	20
		COLUMN			

**Example of a Correct Address Map**

13. Press the **DISPLAY** key on the display's front panel to access the main menu for the display.
14. Press the **NEXT INSTR** softkey until the left-side softkeys shown in the following figure are displayed.

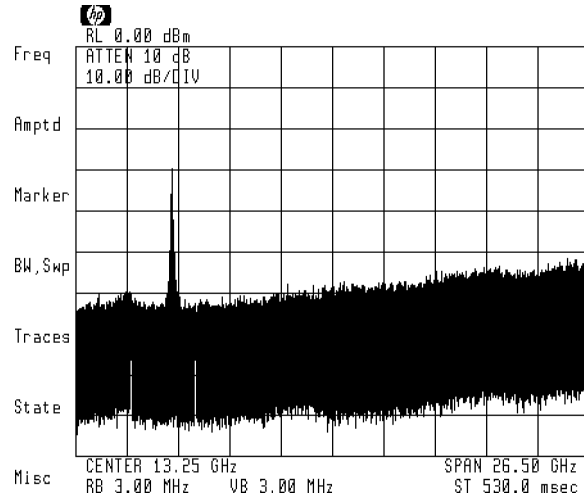

15. Calibrate the two available RF INPUTS using the calibration procedure listed in “Calibrating the HP 71910A” in Chapter 3. The procedure is entitled “To perform a partial calibration with HP 70620B preamp.”

---

## Maintaining the Receiver

The following procedures will help you to maintain the appearance and operation of the HP 71910A Wide-Bandwidth Surveillance Receiver.

### To clean the HP 70004A's screen

- Use a thin-film cleaner and abrasion-free cleaning tissue or soft cloth to clean the display.

An example of a proper thin-film cleaner is the Hewlett-Packard Display Cleaner (HP part number 8500-2163).

---

**CAUTION** Do not use hands or paper towels to clean the display's screen. These abrasive materials may scratch the screen coating.

---

### To change the mainframe's fuse

This procedure applies to either the HP 70001A mainframe or HP 70004A display/mainframe.

1. Turn off the ac line power to the receiver, and remove the line-power cables from the power outlet.
2. Remove the line-power cable from the connector located on the mainframe's rear panel. The fuse holder is located is the line-power cable connector.
3. Use a small flat-blade screwdriver to pry out the fuse holder as shown in the following figure.

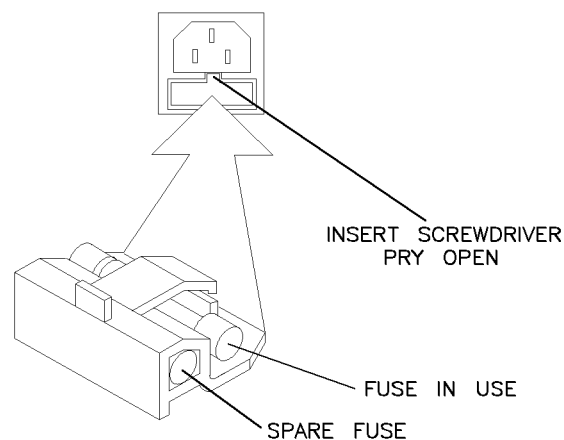

fig13

4. Check the fuse for damage. As shown in the figure, a spare fuse is included in the assembly.

The metric 6.3A fuse (HP part number 2110-0703) can be used with both 120V and 230V power sources.



## To change the custom keypad

The custom keypad snaps into the HP 70004A mainframe's front panel. This keypad gives you quick access to common instrument functions.

In the unlikely event that you need to change the keypad, perform the following step:

- Push the tip of a small flat-bladed screwdriver *straight* into the removal hole, and the keypad will pop out.

---

**CAUTION** Be sure to insert the screwdriver *straight* into the removal hole; do not pry the custom keypad out.

---

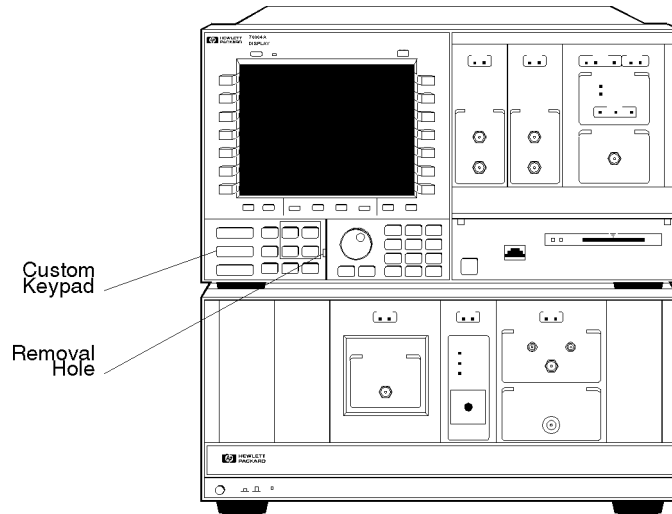

fig22

## To locate a module's serial number

A two-part serial number appears on the mylar label attached to the front frame of the modules. The first four digits and the letter are the serial number prefix; the last five digits, the suffix. Identical receivers have the same prefix, which changes only for significant modification. The suffix is different for each receiver.

1. Open the front-panel door to expose the hex-lock screw.

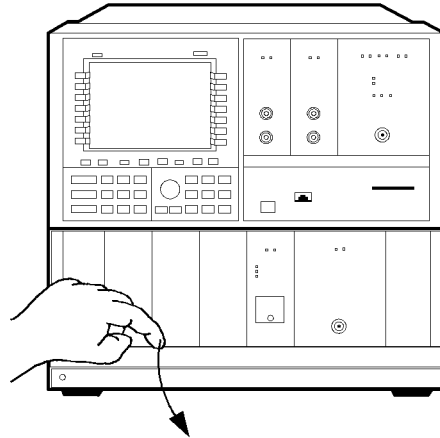

fig5

2. The serial number label is attached to the module's front frame.

---

## Reinstalling the Receiver Personality

In the unlikely event that the receiver personality becomes corrupted or is deleted from memory, this section shows how to reinstall it into the HP 71910A. To determine if the receiver personality is installed, press **USER** and then **RX\_MODE**. The receiver softkey menus should appear on the display.

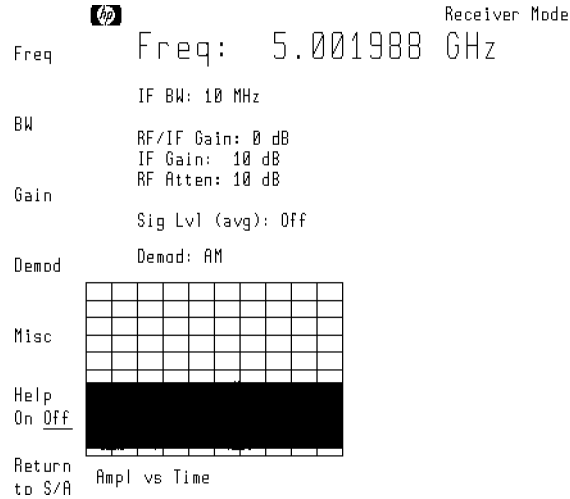

**Receiver Softkey Menu**

Backup copies of the receiver personality are provided in the following forms:

- Memory card.
- 3.5-inch diskette (HP-LIF format).

For standard HP 71910A systems, copy the receiver personality from the memory card. If your HP 71910A is an Option 011 (without HP 70004A display), you must copy the programs from an external HP-IB disk drive. The diskette containing the receiver personality uses the LIF format.

## To install from the memory card

1. Locate the memory card containing the receiver personality.
2. Locate the arrow printed on one end of the card.
3. Insert the card into the HP 70004A display's front-panel card slot. Match the card's arrow with the arrow printed above the card slot as shown in the following figure.

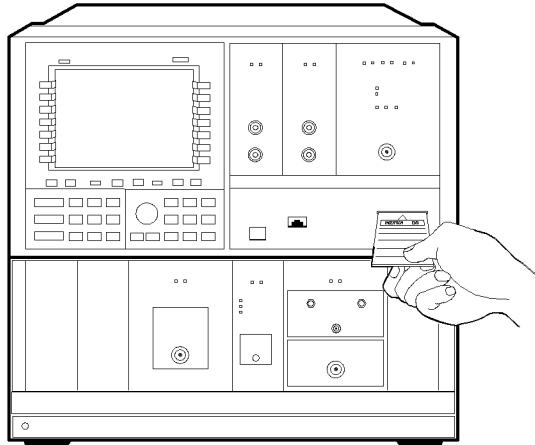

insert

4. Press **MENU** and then the left-side **Misc** softkey.
5. Press **MORE 1 of 3** and then **catalog & MSI**.
6. Press **HP-MSIB CARD** to display all files contained on the memory card.

If 2053 Storage device error is displayed, either the card is missing, the card's write-protect switch is in the SAFE position, or the card's HP-MSIB address is listed incorrectly. The HP-MSIB address for the card is the same address as the display's HP-IB address and is normally set to 4. If the address is not correct, enter the correct address using the numeric keypad.

7. Press **LOAD FILE**, and enter 1 for the file number.
8. Press **ENTER**.

The front-panel LED next to the card slot lights indicating that the files are being copied into the **USER** menu. This process takes approximately 60 seconds.

9. Press **USER** and then **RX\_MODE** to start the receiver personality.

## To install from a 3.5-inch diskette drive

This procedure reinstalls the personality into a standard HP 71910A system. If you have an Option 011 system, perform the next procedure in this section. The disk drive must be a 3.5 inch, CS80-compatible drive, such as an HP 9122.

1. Connect a 3.5-inch diskette drive to the HP 70004A display or HP 70001A mainframe. Use an HP-IB cable.
2. Insert the diskette containing the receiver personality into the diskette drive.
3. Press **MENU**.
4. Press the left-side **Misc** softkey.
5. Press **MORE 1 of 3** and then **catalog & MSI**.
6. Press **HP DISK**, and use the numeric keypad to enter the diskette drive's address.

The default address is 0, unit 0, and volume 0. New addresses are entered in the form *A.UV*, where:

- *A* is a digit from 1 to 30, representing the drive's HP-IB address.
- *U* is a digit from 0 to 9, representing the unit number. The unit number is typically 0 or 1 and refers to an individual disk drive slot.
- *V* is a digit from 0 to 9, representing the volume number. Volume numbers are used for hard disk drives. So, for reading diskettes, the volume number should be 0.

For example, entering *3.00* indicates an address of 3, a unit number of 0 and a volume number of 0. This accesses a diskette in the left drive of an external diskette drive at HP-IB address 3.

7. Press the **ENTER** softkey.

If **2053 Storage device error** is displayed, either a diskette is not in the drive, or the drive's code is incorrectly entered.
8. Press **LOAD FILE**, and enter a 1 for the file number.
9. Press **ENTER** to reinstall the file.

The front-panel LED next to the card slot lights indicating that the files are being copied into the **USER** menu. This process takes approximately 60 seconds.
10. Press **USER** to and then **RX\_MODE** to start the receiver personality.

## To install in an Option 011 instrument

This procedure reinstalls the personality into an Option 011 instrument. It requires the use of a computer and an HP-IB disk drive. The disk drive must be a 3.5 inch, CS80-compatible drive, such as an HP 9122.

In order to use this procedure, you must first write a program that sends a string to the HP 70900B instructing it to load the personality. The string includes a “wait” command that delays the loading of the personality for 20 seconds. This pause gives you time to move the HP-IB cable from the computer to the disk drive. If you need more time, increase this wait value in the command `WAIT 20`.

1. Write a program that sends the following string to the HP 70900B module. (The HP-IB address of the HP 70900B is equal to the HP-MSIB column address of the HP 70900B.)

```
MSI HPIB,0.1; WAIT 20; LOAD /RX/;
```

In the string, the digit 0 represents the disk drive's HP-IB address. The digit 1 represents the individual disk drive slot. This number is typically 0 or 1.

2. Use an HP-IB cable to connect the computer to the HP 70001A mainframe. Do not connect the disk drive to the HP 70001A mainframe or computer.
3. Insert the diskette with the personality into the disk drive.
4. Run the program that you wrote in step 1 of this procedure. You have 20 seconds to complete the next step.
5. Disconnect the HP-IB cable from the computer, and connect it to the disk drive. The disk drive should now be connected to the HP 70001A mainframe.
6. Wait for the personality to load into the HP 70900B.

---

## Returning the Receiver for Service

Repackaging a receiver requires original shipping containers and materials or their equivalents. Hewlett-Packard offices can provide packaging materials identical to the original materials. Refer to Table 10-1 for the Hewlett-Packard sales and service office nearest you.

---

**CAUTION** Packaging materials not specified can result in instrument damage. Never use styrene pellets to package electronic instruments. The pellets do not adequately cushion the instrument, do not prevent all instrument movement, and can generate static electricity.

---

### To return a receiver for service

1. Fill out a blue repair card (located at the end of this chapter) and attach it to the instrument. Send a copy of any noted error messages or other helpful performance data. If a blue repair card is not available, include at least the following information:
  - a. Type of service required
  - b. Description of the problem and whether it is constant or intermittent
  - c. Name and telephone number of technical contact person
  - d. Return address
  - e. Model number of returned instrument
  - f. Full serial number of returned instrument
  - g. List of any accessories returned with instrument
2. To help prevent damage during transit, pack the instrument in the factory packaging materials. Original shipping materials or equivalents are best; however, the following instructions result in acceptable packaging.
  - a. Wrap the instrument in anti-static plastic to reduce the possibility of ESD damage.
  - b. For instruments that weigh less than 54 kg (120 lb), use a double-walled, corrugated cardboard carton of 159 kg (350 lb) test strength. The carton must be both large enough and strong enough to accommodate the instrument. Allow at least three to four inches on all sides of the instrument for packing material.
  - c. Surround the equipment with three to four inches of packing material to protect the module and to prevent movement in the carton. If packing foam is not available, the best alternative is S.D.-240 Air Cap<sup>TM</sup> from Sealed Air Corporation, Hayward, California 94545. Air Cap is plastic sheeting filled with 1-1/4 inch air bubbles. Use pink anti-static Air Cap. Wrapping the instrument several times in this material should provide sufficient protection and also prevent movement in the carton.
3. Seal the carton with strong nylon adhesive tape.
4. Mark the carton FRAGILE, HANDLE WITH CARE.
5. Retain copies of all shipping papers.





## System Verification of Operation

---

### **Use automated tests to verify operation**

The operation verification tests for the HP 71910A are automated tests that are designed to give a high confidence level in the operation of the receiver in a reasonable time. For complete information on requirements, loading, and running the verification test software, refer to the *HP 70000 Modular Spectrum Analyzer Installation and Verification Manual*.

### **Verify performance once every three years**

It is recommended that a complete performance verification be performed once every three years. This can be accomplished by either returning the receiver to Hewlett-Packard or by purchasing the *HP 11990A System Performance Tests* software.



## Operating

---

This chapter shows how to perform measurements using the HP 71910A. Measurements generally involve the following two steps:

1. Use the instrument's spectrum analyzer features to search for a signal.
2. Switch the HP 71910A to receiver mode to downconvert the signal for signal collection.

Entering receiver mode replaces the standard spectrum analyzer softkey menus with new receiver menus. Refer to Chapter 6 for diagrams of the receiver menus. Diagrams of the spectrum analyzer menus are located in the *HP 70000 Modular Spectrum Analyzer Operating Manual*.

### Contents

Calibrating the HP 71910A .....	3-3
To perform a calibration .....	3-3
To perform a calibration with HP 70620B preamp .....	3-3
Searching for Signals (spectrum analyzer mode) .....	3-5
Locating Signals .....	3-6
To change the frequency range .....	3-7
To return to full span .....	3-8
To change the reference level and amplitude scale .....	3-8
To change the amplitude units .....	3-8
Using Markers .....	3-9
To view a signal using markers .....	3-9
Resolving Signals .....	3-11
To resolve closely spaced signals .....	3-11
Reducing Displayed Noise .....	3-12
To reduce the displayed noise .....	3-12
Controlling the Sweep .....	3-13
To change the sweep time .....	3-13
To set continuous or single sweeps .....	3-13
Changing Center-Frequency Step Size .....	3-14
To change the center frequency step size .....	3-14
Collecting Signals (receiver mode) .....	3-15
Changing to Receiver Mode .....	3-17
To switch to receiver mode .....	3-17
To select a new signal .....	3-19
To return to spectrum analyzer mode .....	3-19
Selecting IF Outputs and Channel Filters .....	3-20
To select an IF output .....	3-23
To adjust the IF and video bandwidth .....	3-23
To change the IF-to-video bandwidth ratio .....	3-23
To increase the 321.4 MHz bandwidth .....	

(preselector bypass) .....	3-24
To adjust the IF gain and RF attenuation .....	3-24
To select an Option 007 channel filter .....	3-24
Demodulating Signals .....	3-26
To demodulate the signal .....	3-28
To adjust IQ gain, offset, and quadrature .....	3-28
Viewing the Signal's Average Amplitude Level .....	3-30
To view the average amplitude .....	3-30
Measurement Examples .....	3-31
To search for and collect a pulsed RF signal .....	3-31
To characterize a wide-bandwidth FM signal .....	3-36
To characterize a wide-bandwidth digital transmission .....	3-41
Manually Collecting Signals .....	3-44
Using Manual Mode .....	3-46
To manually enter collection receiver mode .....	3-47
To search for and collect a pulsed RF signal .....	3-49
Using a Preamplifier .....	3-52
To use the HP 70620B preamp .....	3-53
To turn off the preamp in receiver mode .....	3-53
Extending the Frequency Range with External Mixers .....	3-54
Controlling System Configuration .....	3-55
To save a receiver state .....	3-56
To recall or delete a receiver state .....	3-58
To view two instrument windows .....	3-59
To blank the display .....	3-59
To write a title on the screen .....	3-60
Block Diagrams .....	3-62
If You Have a Problem .....	3-65
If UNCOR is displayed .....	3-66
If UNCAL and Usable RBW limited is displayed .....	3-67
If UNCAL and Usable VBW limited is displayed .....	3-68
If Possible compression is displayed .....	3-69
If the PREAMP On Off softkey doesn't work .....	3-70
If there is a frequency shift in an HP 70911A output .....	3-71

---

## Calibrating the HP 71910A

The built-in calibration routine described in this section ensures maximum frequency and amplitude accuracy as specified in Chapter 5 of this manual. The calibration routine determines amplitude and frequency error factors for a number of parameters. For example, a temperature compensation routine is included which decreases temperature induced errors on the HP 70911A. Calibration only requires a few minutes to run.

### To perform a calibration

1. Connect the HP 70900B module's front-panel CALIBRATOR to the HP 70910A RF section's front-panel RF INPUT connector.
2. Press **MENU**.
3. Press the left-side **Amptd** softkey.
4. Press **CAL ALL**.

The calibration takes three or four minutes to complete.

### To perform a calibration with HP 70620B preamp

This procedure calibrates the instrument for both RF INPUT connectors. One input connector is on the HP 70910A RF section and one input is on the HP 70620B preamp.

1. Connect the HP 70900B module's front-panel CALIBRATOR to the HP 70910A RF section's front-panel RF INPUT connector.
2. Press **MENU**.
3. Press the left-side **State** softkey.
4. Press **select input** and then **IN 2 RF 70910A** to select the HP 70910A's RF INPUT connector.
5. Press the left-side **Amptd** softkey.
6. Press **CAL ALL**. The calibration takes three or four minutes to complete.
7. When the calibration is finished, disconnect the cable from the HP 70910A RF section's front-panel RF INPUT connector, and connect the cable to the HP 70620B preamplifier's RF INPUT connector.
8. Press the left-side **State** softkey.
9. Press **select input** and then **IN 1 70620B** to select HP 70620B preamplifier's RF INPUT connector.
10. Press the left-side **Amptd** softkey.
11. Press **CAL ALL**. The calibration takes three or four minutes to complete.

---

## Searching for Signals (spectrum analyzer mode)

This section shows you two methods of searching for signals using the spectrum analyzer functions. With the first method, signals are located by changing the displayed frequency and amplitude range. The second method makes use of powerful marker functions. If your wide-bandwidth surveillance receiver is an Option 011 single mainframe configuration, this search capability will only be available through programming via the HP-IB bus.

Additional spectrum analyzer capabilities are described in the *HP 70900B User's Guide for HP 70900B Instruments* and includes explanations of the following features:

- Three separate color traces.
- Smart marker features including next peak, signal track, and marker pause.
- Oversweep capability for faster sweeps.
- Limit lines and audible beeps for detecting signals above a threshold.
- Three dimensional waterfall displays for time varying signals.

---

**Note** If at any time you want to return the instrument to its start-up condition, press the front-panel **IP** key. This resets all operating parameters without having to turn the power off.

---

**Note** Do not select a resolution bandwidth wider than 3 MHz while searching for signals. If you do, the instrument will not operate as a normal spectrum analyzer. For example, since only linear detection is used for IF bandwidths of 10 MHz to 100 MHz, displayed dynamic range will limit its use for signal searches. For more information, refer to “Manually Collecting Signals” in this chapter.

---

## Locating Signals

Locating a signal is as easy as setting the frequency range and amplitude scale. When the receiver is first turned on, the frequency range is set to the full 100 Hz to 26.5 GHz span. Use the **Freq** menu to change the frequency range. Use the **Amptd** menu to change the reference level and scale. By selecting the softkeys on these two menus, you can view and search for signals.

**Note** In addition to using the softkey menus, don't forget the corresponding front-panel keys. For example, to set the frequency range and reference level use **CENTER**, **SPAN**, **START**, **STOP**, and **REF LEVEL**.

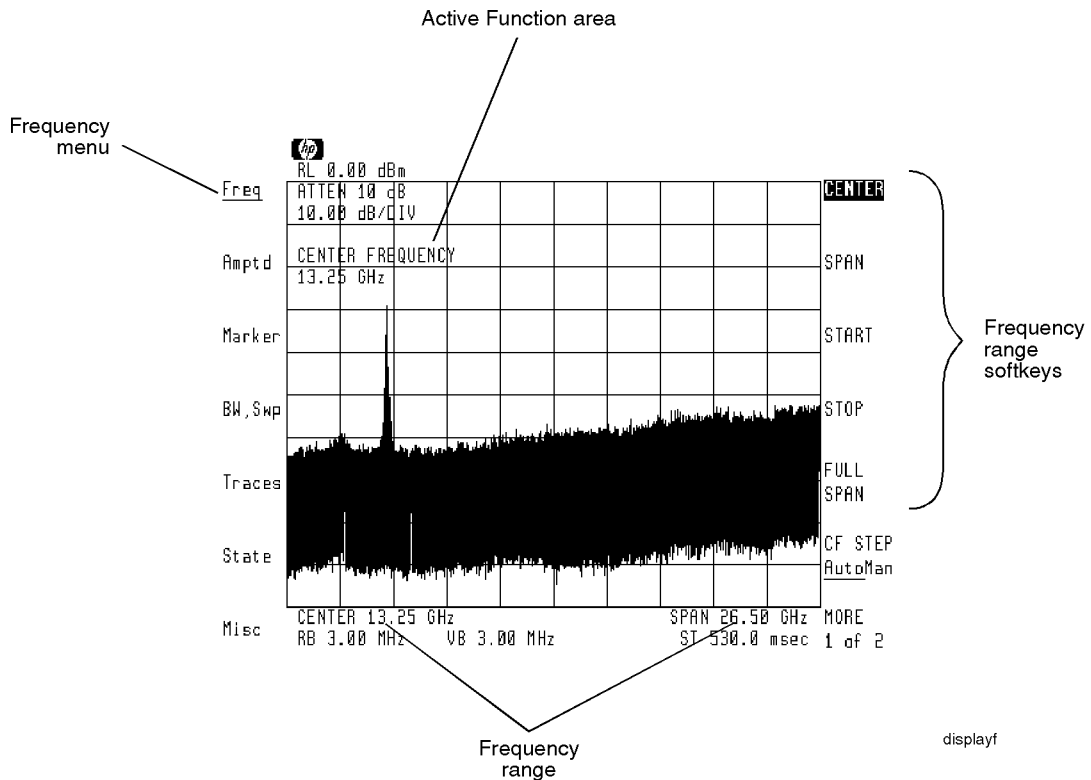

The position of the reference level is located at the top of the display.

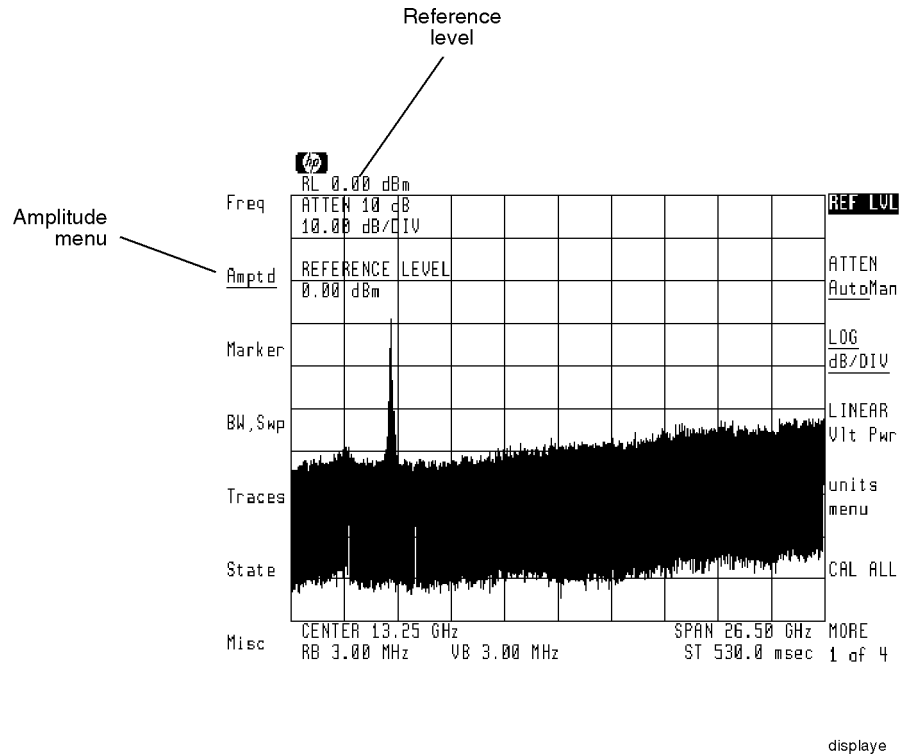

### To change the frequency range

1. Connect an input signal to the front-panel RF INPUT connector.
2. Press the left-side **Freq** softkey.
3. Press the right-side **CENTER** softkey.
4. Rotate the front-panel knob and watch the displayed frequency range move.

After pressing **CENTER**, it becomes the active function, and its value is displayed in the active function area. You can change the value using the knob, step keys, or numeric keypad.

5. Press **SPAN**, and change the displayed frequency span.

You can also change the measurement range by using the **START** and **STOP** softkeys to change the limits of the frequency range.



### To return to full span

1. Press the left-side **Freq** softkey.
2. Press **FULL SPAN**.

### To change the reference level and amplitude scale

1. Press the left-side **Amptd** softkey.
2. Press **REF LVL**, and change the reference level using the knob, step keys, or numeric keypad.
3. Press **LINEAR** to select a linear scale, or press **LOG dB/DIV** to select a logarithmic scale. Then, enter the scale using the knob, step keys, or numeric keypad.

### To change the amplitude units

1. Press the left-side **Amptd** softkey.
2. Press **units menu**.
  - Pressing **A UNITS AutoMan** allows the receiver to select the annotation automatically. The **Auto** selection is the receiver's default setting.
  - Pressing **dBm** selects annotation in decibels relative to 1 mW.
  - Pressing **WATT** selects annotation in watts.

## Using Markers

Markers are small diamond shaped icons that can be moved to any trace point on the display. Markers provide a fast and powerful tool for centering signals on the screen. The frequency and amplitude of the marked trace point are displayed at the top of the screen.

### To view a signal using markers

1. Press **PEAK SEARCH** to activate a marker and place it on the highest trace point.
2. If the signal you want to center is not the highest peak, rotate the knob to place the marker at the desired peak.

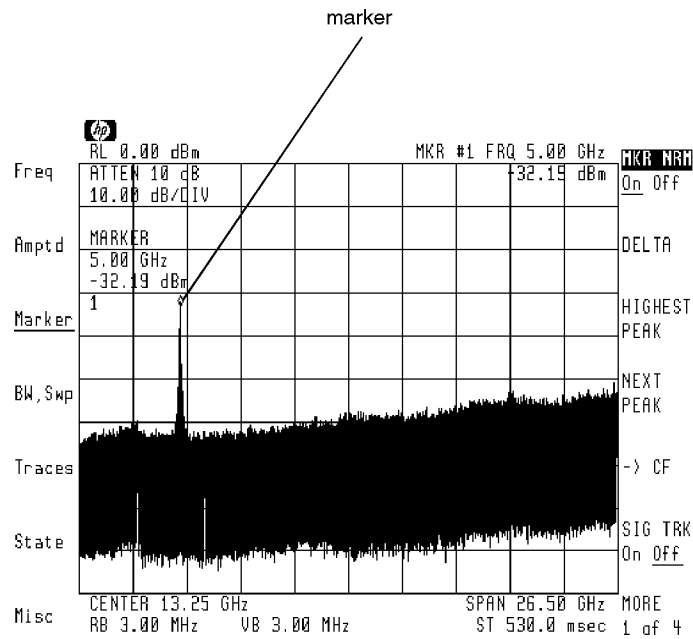

displayc

3. Press the left-side **markers** softkey.
4. Press **-> CF** to move the marked signal to the center of the screen as shown in the following figure.

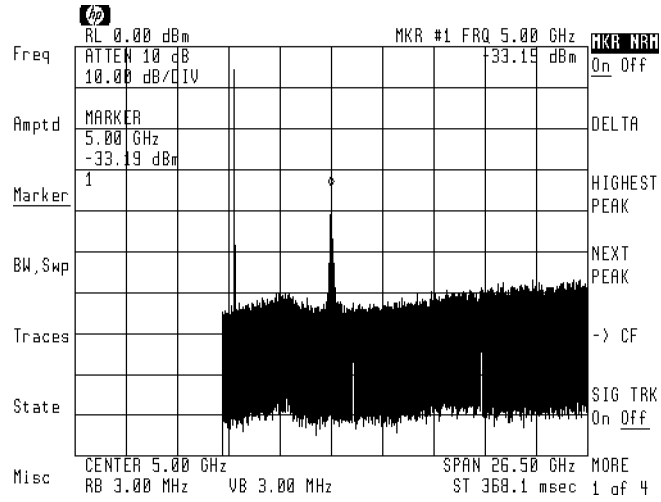

- Press **SPAN**, and use the **▼** key to reduce the frequency range. Here is an example of a pulsed RF signal in a 500 MHz span.

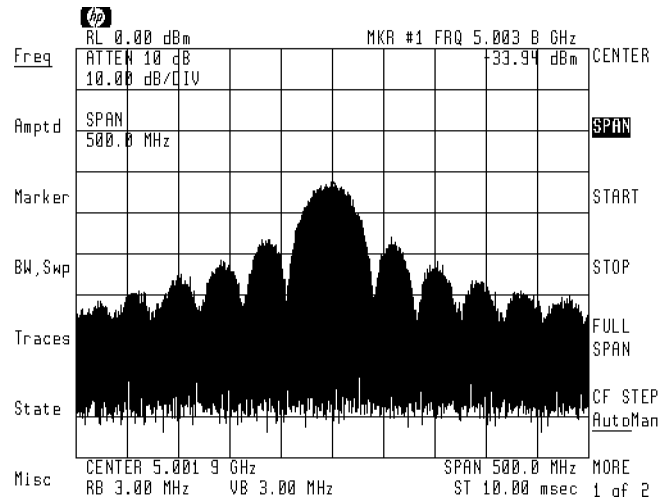

## Resolving Signals

Often, two signals are closely spaced in frequency. The ability to display such signals as two distinct responses is determined by the instrument's resolution bandwidth setting. Normally, the spectrum analyzer automatically selects the optimum resolution bandwidth based on the selected frequency span. As the following figures show, a resolution bandwidth that is too wide causes adjacent signals to appear as one. If a wide resolution bandwidth can hide signals, why not always use the narrowest possible resolution bandwidth? The answer is that as the resolution bandwidth is reduced, the sweep time increases and may slow down signal searches. Manual resolution bandwidths are indicated by an asterisk (\*RB) next to the screen annotation.

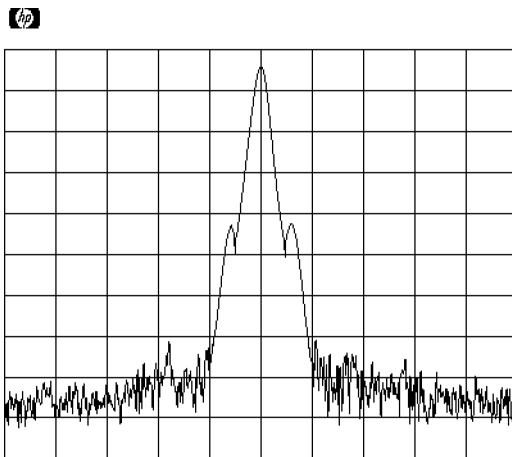

**Wide Resolution Bandwidth**

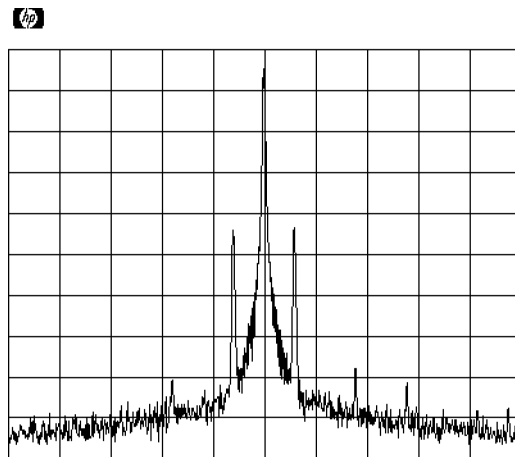

**Narrower Resolution Bandwidth**

### To resolve closely spaced signals

1. Press the left-side **BW,Swp** softkey.
2. Press **RES BW AutoMan**.
3. Press **▼** to reduce the resolution bandwidth. Or, use the knob or numeric keypad to enter a reduced resolution bandwidth.
4. To return to auto coupled resolution bandwidths, press the **RES BW AutoMan** softkey so that **Auto** is underlined.

## Reducing Displayed Noise

The displayed noise level (peak-to-peak noise variation) can be averaged by changing the video bandwidth or by averaging successive traces. Changing the resolution bandwidth changes the absolute level. Normally, the video bandwidth is coupled to the resolution bandwidth and is automatically set. Manually entering a video bandwidth breaks this coupling. Manual video bandwidths are indicated by an asterisk (\*VB) next to the screen annotation.

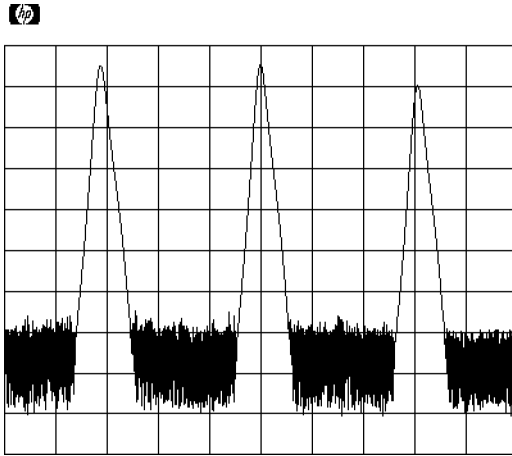

3 KHz Video Filtering

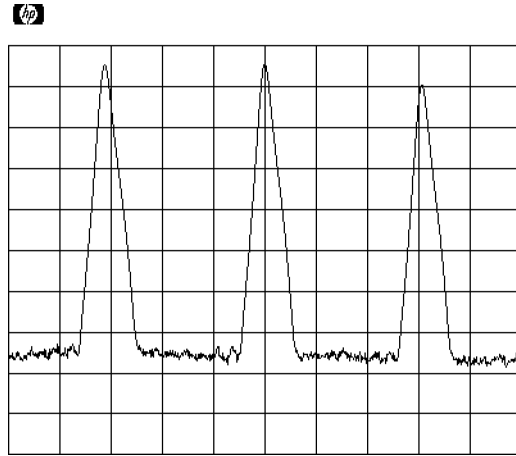

10 Hz Video Filtering

### To reduce the displayed noise

#### ■ Via video bandwidth:

1. Press the left-side **BW,Swp** softkey.
2. Press **VID BW AutoMan** and use the knob, numeric keypad, or **▼** key to reduce the video bandwidth.
3. To return to auto coupled video bandwidths, press the **VID BW AutoMan** softkey so that **Auto** is underlined.

#### ■ Via video averaging:

1. Press the left-side **Traces** softkey to enter the Traces menu. Trace A must be in the clear-write mode.
2. Press **MORE 1 of 4** and then **MORE 2 of 4**.
3. Press the **VID AVG On Off** softkey so that **On** is underlined.
4. Enter the number of sweeps to average the displayed trace. Or, use the default of 100 trace averages.
5. Press **VID AVG On Off** to **Off** and then **On** to restart averaging at any time.

## Controlling the Sweep

The sweep speed is automatically set by the receiver. In fact, the receiver always uses the fastest sweep possible while still maintaining a calibrated display. Manually setting the sweep time disrupts the coupling used to maintain a calibrated display. Whenever a sweep time is selected that degrades accuracy, the uncalibrated warning, `UNCAL`, appears on the display.

### To change the sweep time



1. Press the left-side `BW, Swp` softkey.
2. Use the knob, step keys, or numeric keypad to enter the desired sweep time.
3. To reestablish sweep time coupling, press `SWPTIME AutoMan` so that `Auto` is underlined.

### To set continuous or single sweeps



1. Press the left-side `BW, Swp` softkey.
2. Press one of the following softkeys:
  - `CONT SWEEP` to use continuous sweeping.
  - `SINGLE SWEEP` to sweep the measurement range once.

To repeat another single sweep, press `SINGLE SWEEP` again.

## Changing Center-Frequency Step Size

When center frequency is the active function, pressing the  and  keys steps the center frequency to a new value. The default step size is one tenth of the displayed frequency span. You can change the size of the steps to meet your search needs. The value you enter does not depend upon the displayed span; you can jump to frequencies that are not currently displayed.

### To change the center frequency step size

1. Press the left-side **Freq** softkey.
2. Press the **MORE 1 of 2** softkey.
3. Press **FREQ STEP AutoMan** and use the knob, step keys, or numeric keypad to enter a new center frequency step size.
4. Press **CENTER** to activate the center frequency function.
5. Press  or  to step the center frequency.

---

## Collecting Signals (receiver mode)

This section shows you how to use the receiver mode. Entering receiver mode changes instrument operation in the following manner:

- Displays receiver menus.
- Sets fixed-tuned operation (zero span with the display showing amplitude versus time.)
- Sets center frequency to the marker frequency or, if no marker is displayed, to the frequency of the highest amplitude input signal.
- Sets amplitude scale to linear.
- Places reference level relative to the highest peak.
  - The reference level is set to the next highest multiple of 10 dB from the peak's value. For example, if the signal peak measures 26 dBm, the reference level is set to 30 dBm.
- Downconverts the signal for analysis.
- Selects a 10 MHz or wider IF bandwidth.
- Selects a 10 MHz or wider video bandwidth.
- Selects AM demodulation.
- Provides visual feedback that the signal is present (an amplitude versus time display). Only linear detection (not logarithmic) is available when IF bandwidths are greater than or equal to 10 MHz.

Press **USER** to enter receiver mode.

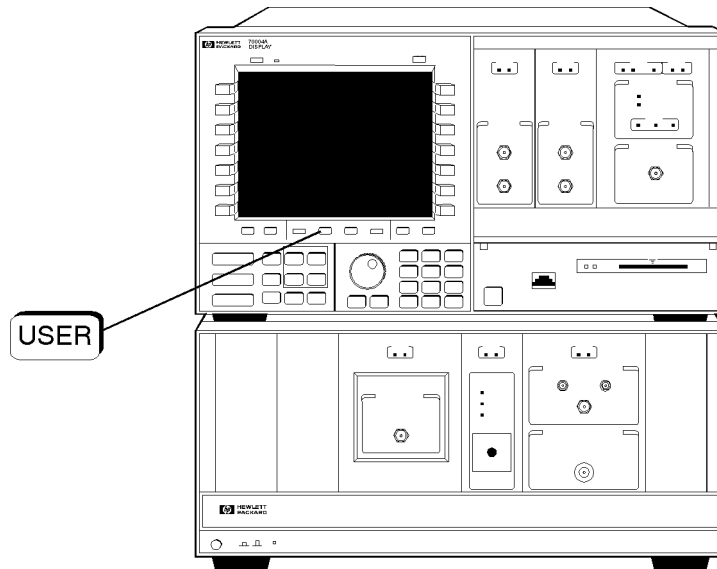

fig20



---

**Note** Receiver mode is actually a special program called a “personality” or “downloadable program.” Personalities provides new menus and features and are accessed through the front-panel **USER** key. You can even write your own personalities. To learn how to create your own personalities, refer to the *HP 70900B Programmer’s Guide for HP 70900B Instruments*.

---

**Note** Due to harmonic mixing process utilized in the receiver, the signals at the IF, FM, and IQ outputs will be inverted when the receiver is tuned to frequencies of 12.8 GHz and below. The “minus” mixing mode is used for this tuning range. The “plus” mixing mode is used when the receiver is tuned from 12.6 to 26.5 GHz, so no inversion occurs for this range.

---

In receiver mode, online help is available for each softkey. To access online help, press the left-side **Help On Off** softkey so that **On** is underlined. Then, press a softkey to learn about its application.

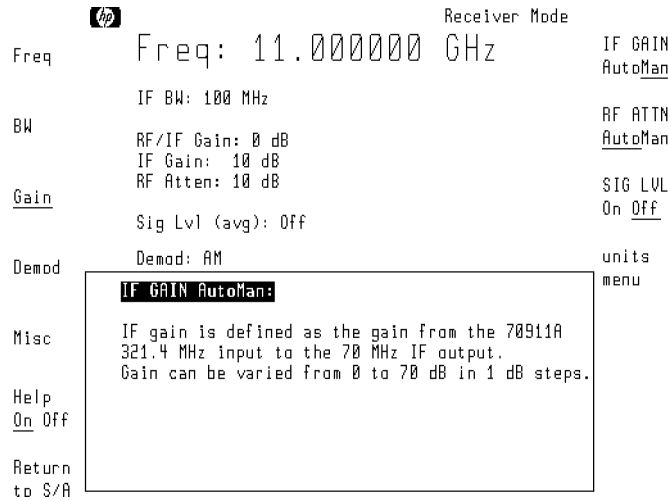

**Online Help for IF GAIN AutoMan Softkey**

---

**Note** The receiver mode is accessed with the **USER** key. In addition, it is possible to use many of the keys found under the **MENU** key, such as markers. However, to access certain functions, such as **CAL ALL**, first exit the receiver mode, and use the spectrum analyzer functions found in the **MENU** key area.

---

## Changing to Receiver Mode

The procedures in this section show you how to switch between receiver and spectrum analyzer modes. In receiver mode, a small display shows the input signal's amplitude versus time. Use this display to quickly confirm that the signal is present and that the receiver is properly tuned. For convenience, this fixed-tuned display can be changed to the normal spectrum analyzer display. This allows you to select another signal for down conversion without leaving receiver mode. Because a linear amplitude scale is used (and a linear detector), the displayed dynamic range is limited.

### To switch to receiver mode

1. Press **USER** and then **RX\_MODE**.
  - If there are no markers shown on the screen, the instrument automatically tunes to the highest displayed peak.
  - If a marker is on, the instrument tunes to the signal at the marked frequency.

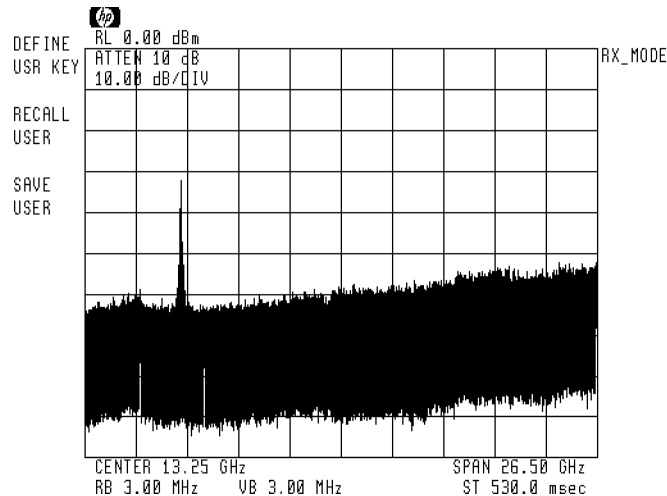

The **RX\_MODE** Softkey

2. Once the receiver is fix-tuned to the desired signal, the downconverted IF signal is available at the HP 70911A module's rear panel for processing.

The standard rear-panel IF output is centered at 321.4 MHz. Option 001 and 002 provide additional 70 MHz and 140 MHz IF signals respectively. For more information on IF outputs including Option 007 channel filters, refer to the next section in this chapter.

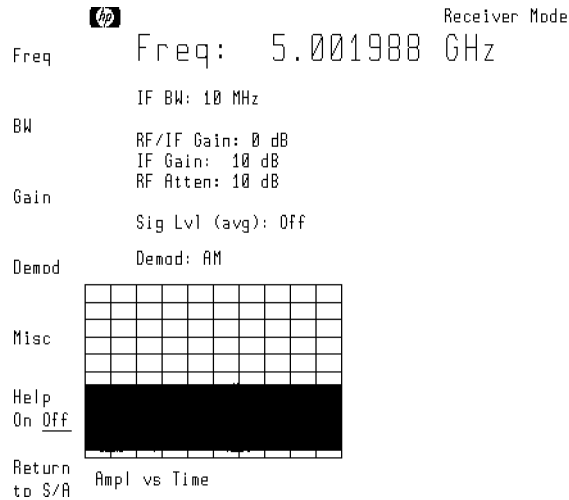

**The receiver personality menus.**

3. To demodulate the downconverted signal, perform the following steps:
  - a. Press the left-side **Demod** softkey, and then press the softkey that corresponds to the type of demodulation desired.
 

**AM** and **PULSE** demodulation formats are standard on the HP 71910A. Option 004 and 005 provide additional I/Q and FM formats respectively.
  - b. Connect the appropriate external test equipment to the front-panel demodulation output connector. AM and pulse are accessed via the **VIDEO** output. FM and I/Q are clearly marked if those options are present.

---

**Note** The demodulated outputs are always “on” at the front-panel connectors, regardless of whether they are selected by the **Demod** softkey. The softkey is necessary to toggle between AM and pulse modes which share the same **VIDEO** connector. The softkey also toggles between FM wideband and FM narrowband which share the same **FM** connector. The softkey also offers certain adjustments to the FM and IQ modes as described in this chapter.

---

### To select a new signal

1. Press **SPAN**.
2. Use the front-panel knob, step keys, or numeric keypad to change the displayed frequency span.
3. Press the left-side **Freq** softkey.
4. Press **CENTER**, and use the front-panel knob, step keys, or numeric keypad to enter a new receiver frequency.
5. To return to fixed-tuned operation, press **SPAN** and enter a span of 0 Hz.

### To return to spectrum analyzer mode

Press the left-side **Return to S/A** softkey, and select one of the following to return to the search receiver mode:

- **LAST STATE** to return the spectrum analyzer to the state it was in before the personality was started.
- **FULL SPAN** to return the spectrum analyzer to its widest frequency span. (100 Hz — 26.5 GHz Instrument Preset condition.)
- **NARROW SPAN** to return the spectrum analyzer to a frequency span wide enough to display the input signal. (The span is set to a value of ten times the IF bandwidth. The IF bandwidth is not changed.)

## Selecting IF Outputs and Channel Filters

The IF outputs are available at the HP 70911A module's rear panel.

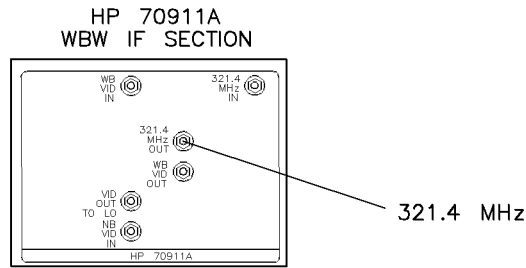

fig18

### Standard IF Outputs

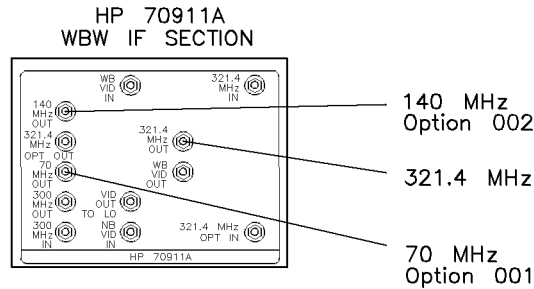

fig19

### Option 001 and Option 002 IF Outputs

The level of the IF signal can be adjusted to the requirements of the external equipment by applying RF attenuation or IF gain. Up to 65 dB of attenuation is available in 5 dB steps. The amount of gain applied to the input signal is displayed on the screen as **RF/IF Gain**. This represents the gain from the front-panel **RF INPUT** connector to the Option 001 rear-panel **70 MHz** output connector. Without an HP 70620B preamplifier present, the **RF/IF Gain** is defined by the following equation:

$$RF/IF\ Gain = IF\ gain - RF\ attenuation$$

For more information on how this gain is calculated, refer to “RF/IF Gain” in Chapter 7.

```

Receiver Mode
Freq      Freq: 11.000000 GHz      IF GAIN
AutoMan
          IF BW: 100 MHz
BW        RF/IF Gain: 0 dB      RF ATTN
AutoMan
          IF Gain: 10 dB
Gain      RF Atten: 10 dB      SIG LVL
On Off
          Sig Lvl (avg): Off
Demod     Demod: AM           units
menu
          IF GAIN AutoMan:
Misc      IF gain is defined as the gain from the 70911A
          321.4 MHz input to the 70 MHz IF output.
          Gain can be varied from 0 to 70 dB in 1 dB steps.
Help
On Off
Return
to S/A

```

With 0 dB RF attenuation and 0 dB IF gain, the RF/IF gain from the HP 70910A's RF INPUT connector to the HP 70911A's IF output connectors is as follows:

```

321.4 MHz IF output ..... +5 dB
70 MHz IF output ..... 0 dB
140 MHz IF output ..... -10 dB

```

You can apply up to 70 dB of IF gain in 10 dB steps using the step keys or 1 dB steps using the knob or data entry keys. This gain is manually applied; there is no automatic gain control.

---

**Note** When Option 001 or 002 is installed, the 321.4 MHz IF is available at the rear-panel 321.4 MHz OPT OUT connector. This 321.4 MHz output has degraded IF bandwidth accuracy.

---

**Note** If you need to preserve the phase information of a signal, use an oscilloscope or deep-memory IF digitizer to process the 70 MHz IF output of the receiver.

---

If you're downconverting signals between 2.7 and 26.5 GHz, you must turn off the microwave preselector to obtain the widest possible IF bandwidth. For example, if you select a 100 MHz IF bandwidth, but the microwave preselector is on, the effective bandwidth will be limited to greater than 36 MHz at the HP 70911A's 321.4 MHz IF output. This is shown in the following table:

### Approximate Widest Bandwidth of HP 70911A IF Outputs

Frequency	321.4 MHz Output	70 MHz Output <sup>1</sup>	140 MHz Output <sup>2</sup>
100 Hz—2.9 GHz	>48 MHz	40 MHz	>48 MHz
2.7—26.5 GHz			
preselector on	>36 MHz <sup>3</sup>	>36 MHz	>36 MHz
preselector off	100 MHz	40 MHz	70 MHz

1 Option 001

2 Option 002

3 The preselector's bandwidth increases at higher frequencies and is nearly 60 MHz at a center frequency of 20 GHz.

### To select an IF output

- The 321.4 MHz IF output is always available at the HP 70911A module's rear panel. On Option 001 instruments, the 70 MHz IF output is always available. On Option 002 instruments, the 140 MHz IF output is always available.

### To adjust the IF and video bandwidth

1. Press the left-side **BW** softkey.
2. Press **IF BW**, and use the front-panel knob, step keys, or numeric keypad to change the IF bandwidth. The IF filters are adjustable in 10% increments (10 MHz, 11.1 MHz, 12.2 MHz, etc.) using the knob. The filters are synchronously tuned (Gaussian approximation).

When **Man** is underlined in the softkey, the IF bandwidth is uncoupling from the video bandwidth. To recouple these parameters, press the softkey so that **Auto** is underlined.

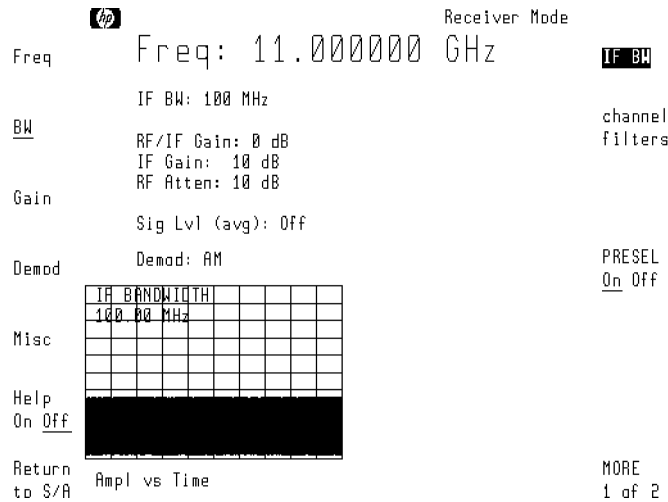

3. Press **MORE 1 of 2**.
4. Press **VID BW AutoMan**, and use the front-panel knob, step keys, or numeric keypad to change the video bandwidth.

When **Man** is underlined in the softkey, the IF bandwidth is uncoupling from the IF bandwidth. To recouple these parameters, press the softkey so that **Auto** is underlined.

### To change the IF-to-video bandwidth ratio

1. Press the left-side **BW** softkey.
2. Press **MORE 1 of 2**.
3. Press **VBW/IFB RATIO**, and use the front-panel knob, step keys, or numeric keypad to change the ratio.



### To increase the 321.4 MHz bandwidth (preselector bypass)

1. Press the left-side **BW** softkey.
2. Press **PRESEL On Off** so that **Off** is underlined.

### To adjust the IF gain and RF attenuation

1. Press the left-side **Gain** softkey.
2. To adjust the IF gain, press **IF GAIN AutoMan**, and use the front-panel knob, step keys, or numeric keypad to change the displayed value.
3. To adjust the RF attenuation, press **RF ATTN AutoMan**, and use the front-panel knob, step keys, or numeric keypad to change the displayed value.

The amount of gain applied to the input signal from the RF input connector to the 70 MHz IF output is displayed on the screen as **RF/IF Gain**.

### To select an Option 007 channel filter

With Option 007 installed, Chebyshev channel filters can be switched into the Option 001 70 MHz IF path. These filters provide bandwidths of 1.25, 5, 10, 20, and 36 MHz. The following figure shows the shape of the 5 MHz channel filter. It was created by viewing the 70 MHz output on a separate spectrum analyzer.

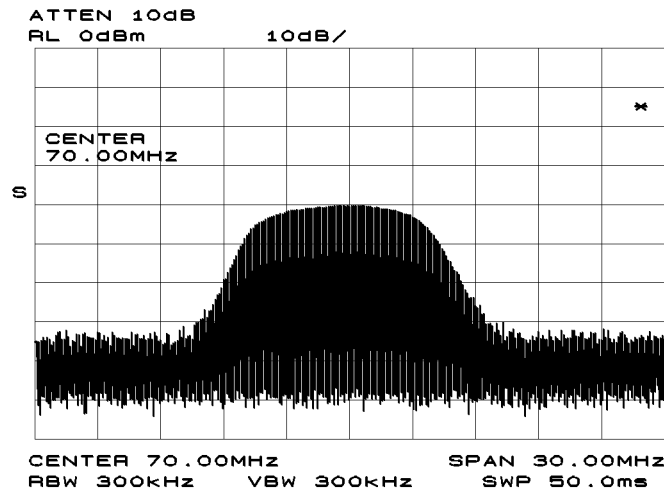

**Option 007 5 MHz Channel Filter**

---

**Note** This procedure requires that Option 007 be installed in the HP 71910A.

---

1. With Option 007 installed, press the left-side **BW** softkey.

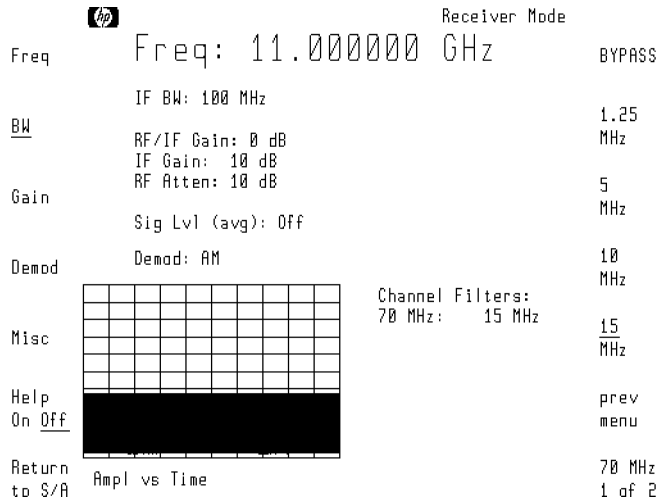

The figure shown above is an example of a custom channel filter option which includes a 15 MHz bandwidth filter instead of a 20 MHz bandwidth filter. Custom channel filters are available as factory-installed options.

2. Press **channel filters** and then **70 MHz**.
3. Press a softkey to select one of the following choices:
  - **1.25 MHz**, **5 MHz**, **10 MHz**, **20 MHz**, or **36 MHz** to select the desired IF filter bandwidth.
  - **BYPASS** to prevent any channel filtering.

## Demodulating Signals

The video outputs are available on the HP 70911A module's front panel. The default demodulation is AM. When the receiver mode is started, any amplitude modulation information present on the signal is demodulated and made available at the HP 70911A module's front-panel VIDEO connector.

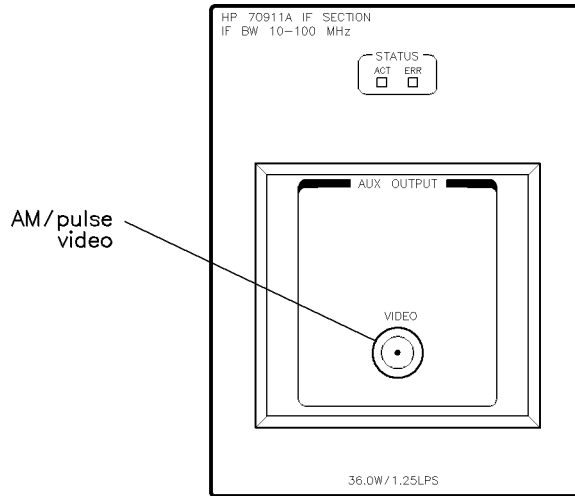

fig1

### Standard Video Output

If you have an Option 004 or Option 005 receiver, the following outputs are available:

- Analog IQ (Option 004)
- FM (Option 005)

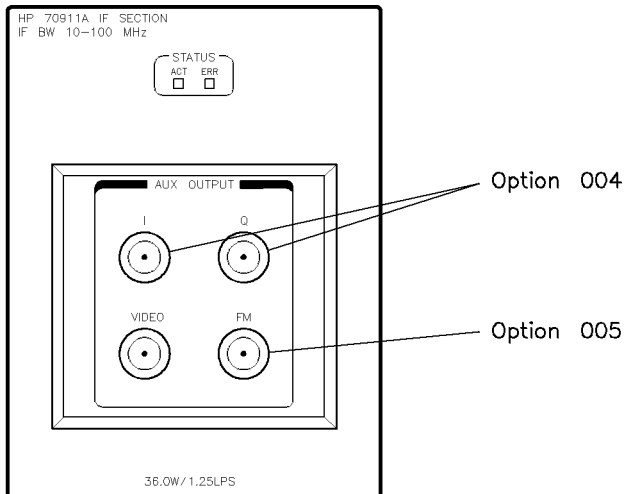

fig2

### Optional Outputs

### Two FM discriminator gains are available

Option 005 provides FM discriminators selections for 10 MHz and 40 MHz deviation. The discriminator is based on a delay line design. Modulation frequencies up to half the bandwidth can be demodulated (up to 12 MHz maximum). For example, with a deviation of 10 MHz, a modulation frequency of 5 MHz can be processed.

### Use analog IQ for constellation displays

Option 004 analog IQ demodulation is useful for applications requiring constellation displays. You'll need a two-channel oscilloscope in X-Y mode to display a constellation. Because each output has a bandwidth of 50 MHz, the overall bandwidth is 100 MHz.

You can adjust the gain, offset, and quadrature of the IQ outputs. The offset should be adjusted to zero volts for each output. Quadrature adjusts the phase difference between the outputs to 90° and, along with gain, is used to optimize the shape of constellations that are displayed on an oscilloscope.

### If maximum bandwidth is important

In situations where maximum bandwidth is important, the IQ demodulation offers an advantage over using 70 MHz or 140 MHz down conversion as shown in the following table.

**Bandwidth Comparison**

	<b>Bandwidth</b>
<b>Option 001 70 MHz IF</b>	40 MHz
<b>Option 002 140 MHz IF</b>	70 MHz
<b>Option 004 Analog IQ</b>	100 MHz

## To demodulate the signal

1. Press the left-side **Demod** softkey.
2. Select from one of the following demodulation formats:
  - **AM** selects AM demodulation of the downconverted signal. The demodulated output is available at the front-panel **VIDEO** connector. (video bandwidth = 0.3 x IF bandwidth.)
  - **PULSE** selects pulse demodulation of the IF signal. The demodulated output is available at the front-panel **VIDEO** connector. (Video bandwidth is set to 100 MHz.)
  - **FM WB** selects wide-bandwidth FM demodulation of the IF signal. This softkey is only available on Option 005 instruments. The demodulated output is available at the front-panel **FM** connector. (FM peak-to-peak deviation of 40 MHz or less can be demodulated.)
  - **FM NB** selects narrow-bandwidth FM demodulation of the IF signal. This softkey is only available on Option 005 instruments. The demodulated output is available at the front-panel **FM** connector. (FM peak-to-peak deviation of 10 MHz or less can be demodulated.)
  - **IQ** selects analog IQ processing of the IF signal. This softkey is only available on Option 004 instruments. The output is available at the front-panel **I** and **Q** connectors.

The offset and gain of the I and Q channels can be independently adjusted as described in “To adjust IQ gain and offset” in this section.

## To adjust IQ gain, offset, and quadrature

1. Connect an oscilloscope or voltmeter to the front-panel **I** and **Q** outputs so that they can be monitored.
2. Press the left-side **Demod** softkey.
3. Press the **IQ** softkey.
4. Press **I GAIN** or **Q GAIN** and rotate the front-panel knob to adjust the gain of each output so that they are equal.

The displayed gain setting is a unitless digital-to-analog (DAC) value between 0 and 4095.

5. Press **I OFFSET** or **Q OFFSET**, and rotate the front-panel knob to adjust the offset of each output to zero volts.

The displayed offset setting is a unitless digital-to-analog (DAC) value between 0 and 4095.

6. Press **QUADRATURE** and rotate the front-panel knob to optimize the shape of the displayed constellation,.

The displayed offset setting is a unitless digital-to-analog (DAC) value between 0 and 4095.

## Viewing the Signal's Average Amplitude Level

You can display the signal's average amplitude level in receiver mode. The average is computed at the end of every sweep and is shown in either linear or logarithmic units. You can select the units that are used.

### To view the average amplitude

1. Press the left-side **Gain** softkey.
2. Press **units menu**.
3. Press the softkey corresponding to the desired units.

To return to the default units, press **A UNITS AutoMan** so that **Auto** is underlined.

4. Press **prev menu**.
5. Press **SIG LVL On Off** to display the average amplitude value.

---

**Note** Pulse modulated signals having narrow pulse widths (and corresponding large desensitization) will have lower average level readings than actual due to the peak detector bandwidth of the digitizing hardware used to display the signal.

---

## Measurement Examples

The following measurement examples provide step-by-step instructions on using the receiver.

### To search for and collect a pulsed RF signal

This procedure shows how to search for and collect (demodulate) a pulsed RF signal. The demodulated video signal is viewed on an HP 70703A Digitizing Oscilloscope. (The HP 70703A is sold separately and is not included in with the HP 71910A.) Of course, you can substitute any suitable oscilloscope.

The HP 70703A oscilloscope's 8 bit, 20 Ms/s digitizer is useful for signals which are greater than 100 MHz in bandwidth and are repetitive in nature. Because the oscilloscope is an MMS product both its display and that of the spectrum analyzer can be viewed simultaneously on the screen.

1. Connect the signal to the HP 71910A's front-panel RF INPUT connector.
2. Connect the HP 70911A's front-panel VIDEO connector to the HP 70703A oscilloscope's front-panel channel 1 connector.
3. On the HP 71910A, press **PEAK SEARCH** to position a marker on the highest signal.
4. If this is not the desired signal, use the **NEXT PEAK** key. Or, press **Marker** and use the front-panel knob to place a marker on the signal of interest.

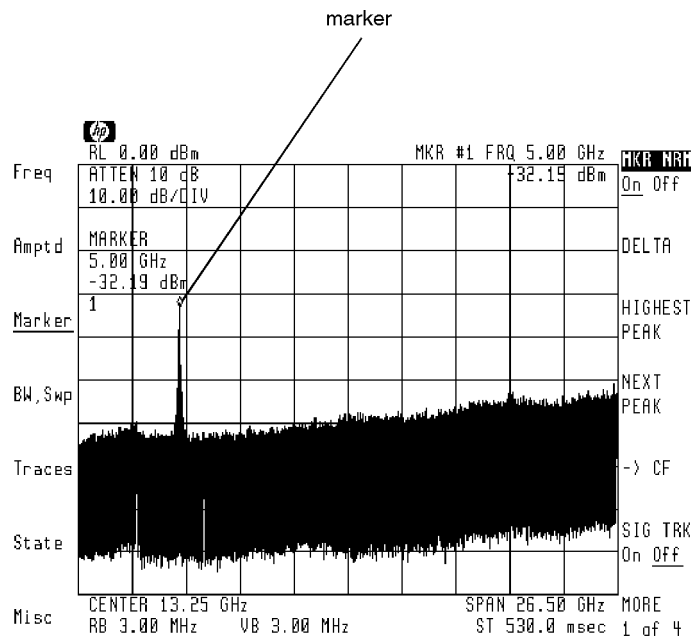

displayc

5. Press **USER** and then **RX\_MODE** to start the receiver personality.

Receiver mode will perform a peak search if no marker has been turned on. It then centers the signal and fix tunes the local oscillator (zero span).

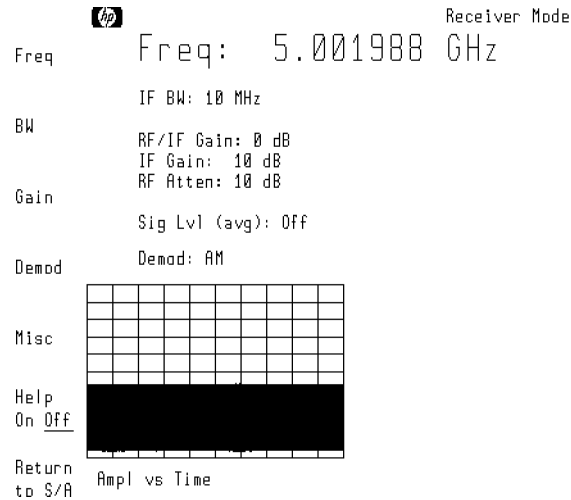

6. Press the left-side **BW** softkey.

Notice that the **IF BW** function is automatically selected.

7. Press the **⇩** key twice to set the IF bandwidth to 100 MHz.
8. If the signal's center frequency is above 2.7 GHz, press **PRESEL On Off** so that **Off** is underlined.

This step increases the bandwidth by turning off the microwave preselector

9. If you need to adjust the IF gain, perform the following steps:
  - a. Press the left-side **Gain** softkey. The **IF GAIN AutoMan** function is automatically selected.
  - b. Use the **⇩** and **⇩** keys to change the IF gain to a value suitable for the signal level.
10. Press the left-side **Demod** softkey and then press **PULSE**.

This sets the video bandwidth equal to 100 MHz bandwidth. With the default AM demodulation, the video bandwidth is equal to approximately one third the value of the IF bandwidth.

11. Press **DISPLAY**.
12. Press the left-side **Config Display** softkey.
13. Press **build window** and then **STACK 2 WINDOWS**.

Notice that when two windows are displayed, the receiver's small frequency-versus-time screen is removed.



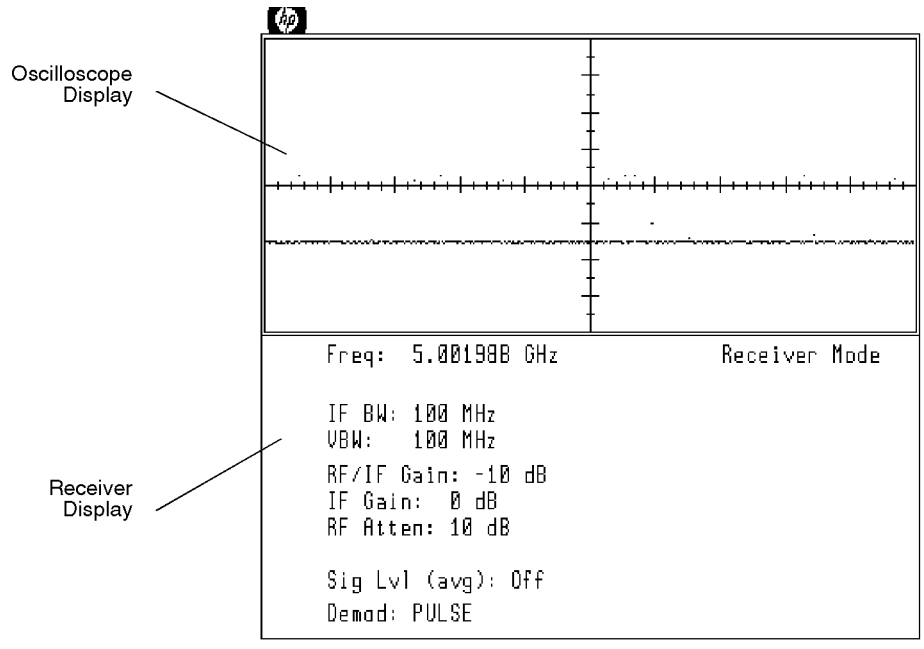

displayd

14. Press **INSTR**.
  15. Press left-side **70703A** softkey to select the oscilloscope as the active instrument window.
- The oscilloscope's softkeys now appear.

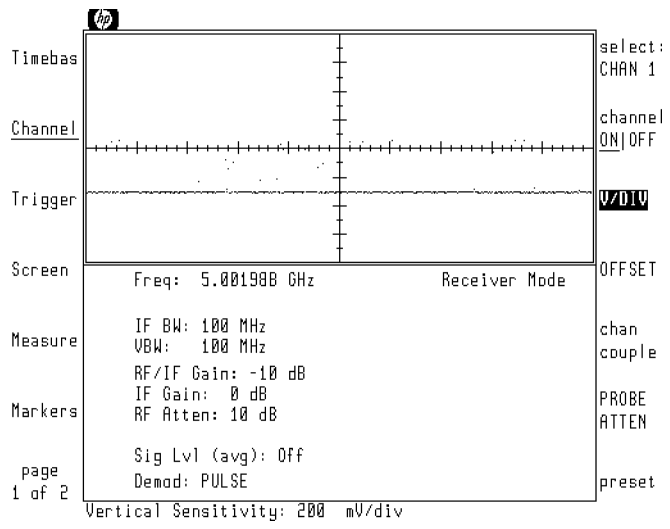

16. Press **USER** to display additional oscilloscope softkeys.
17. Press **AUTO SCALE**.

18. If the sweep time needs to be adjusted, perform the following steps:
  - a. Press the **USER** key.
  - b. Press **SEC/DIV**, and change the sweep time as needed.
  - c. Press the **MENU** key.
19. Press the **MENU** key so that the left-side **Trigger** softkey is displayed.
20. Use the front-panel knob to adjust the trigger level for a stable display.

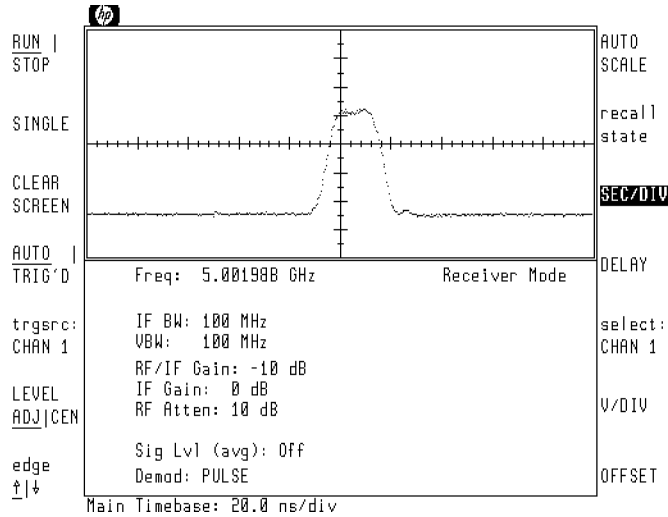

21. Press the left-side **Measure** softkey.
22. Press **more 1 of 4**, and select the desired measurements.

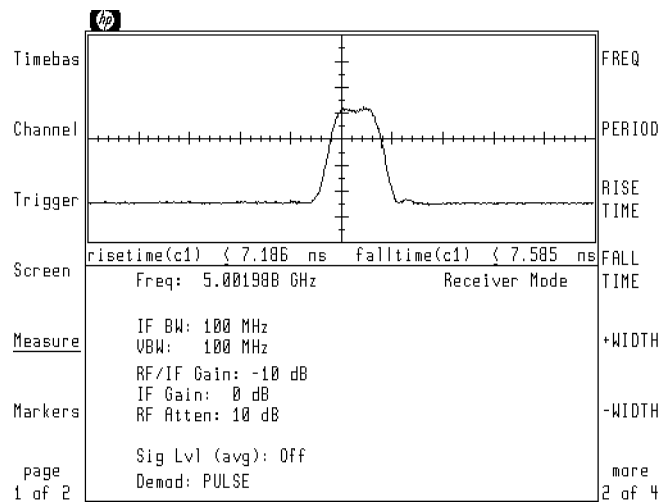

23. Press **INSTR** and then **70900B** to return to the receiver menus.

24. To search for another pulse signal to downconvert, do the following steps:
  - a. Press **USER** to view the receiver personality's menus.
  - b. Press **Return to S/A**.
  - c. Press **FULL SPAN**.

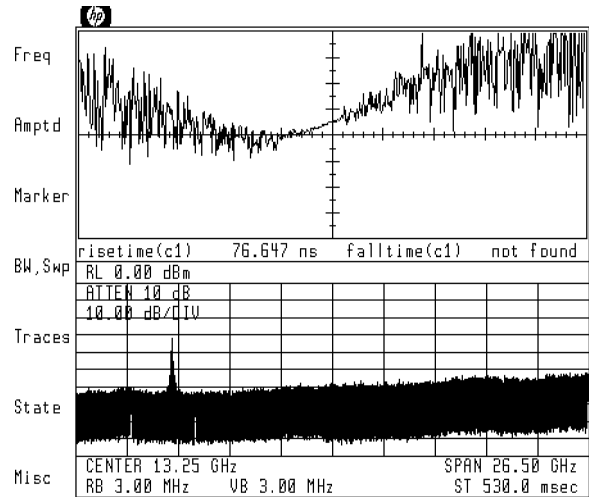

---

**Note** Since the receiver is no longer in zero span (fix tuned), the oscilloscope display will appear random.

---

## To characterize a wide-bandwidth FM signal

This procedure demonstrates how to characterize frequency chirp that is present on a radar pulse. The demodulated video signal is viewed on an MMS HP 70703A Digitizing Oscilloscope. The HP 70703A is not part of the HP 71910A and must be ordered separately. Of course, you can substitute any suitable oscilloscope.

---

**Note** In order to perform this task, the HP 71910A must have Option 005 installed.

---

1. Connect the signal to the HP 71910A's front-panel RF INPUT connector.
2. Press the left-side **BW,Swp** softkey.
3. Press **SWPTIME AutoMan**, **(1)**, and then **s** to increase the sweep time to 1 second.

Increasing the sweep time allows the spectral lobes of the radar signal to be viewed.

4. Repeat the following steps until a main lobe of the signal is displayed as shown in the following figure:
  - a. Press **(PEAK SEARCH)**.
  - b. Use the front-panel knob or **(NEXT PEAK)** key to place the displayed marker on the signal.
  - c. Press the left-side **Marker** softkey.
  - d. Press **-> CF** to center the signal.
  - e. Press **(SPAN)**, and use the **(D)** key to reduce the frequency span so that the main lobes of the signal are displayed.

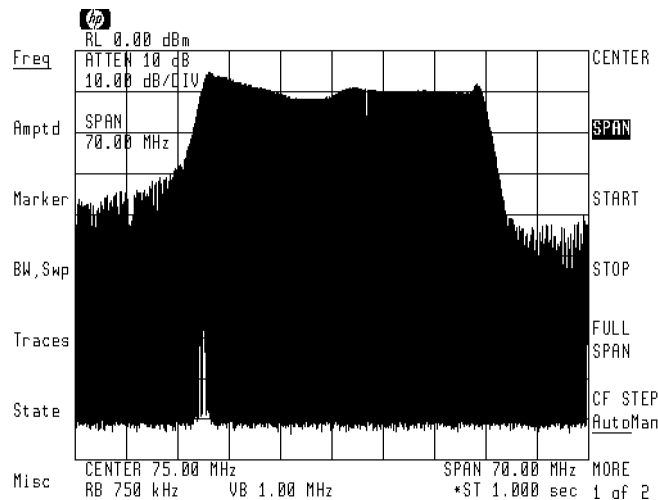

---

**Note** Because the displayed spectrum may have several peak amplitudes, the receiver personality may not be able to identify the correct center frequency. To avoid this, the following steps manually place the spectrum analyzer in zero span before entering the receiver mode.

---

5. Press **CENTER** and rotate the front panel knob to center the displayed response. Then, press **SPAN**, **0**, and then **Hz**.
6. Connect HP 70911A's front-panel FM connector to the HP 70703A oscilloscope module's front-panel channel 1 connector.
7. Press **USER**.
8. Press **RX\_MODE**.
9. Press the left-side **BW** softkey.

Notice that the **IF BW** function is automatically selected.

10. Press the **↑** key several times to set the IF bandwidth to 100 MHz.
11. If the signal's center frequency is above 2.7 GHz, press **PRESEL On Off** so that **Off** is underlined.

This step increases the bandwidth by bypassing the microwave preselector

12. If you need to adjust the IF gain, perform the following steps:
  - a. Press the left-side **Gain** softkey. The **IF GAIN AutoMan** function is automatically selected.
  - b. Use the **↓** and **↑** keys to change the IF gain.
13. Press the left-side **Demod** softkey.
14. Press **FM WB**.

This selects the FM wide-bandwidth (40 MHz) discriminator.

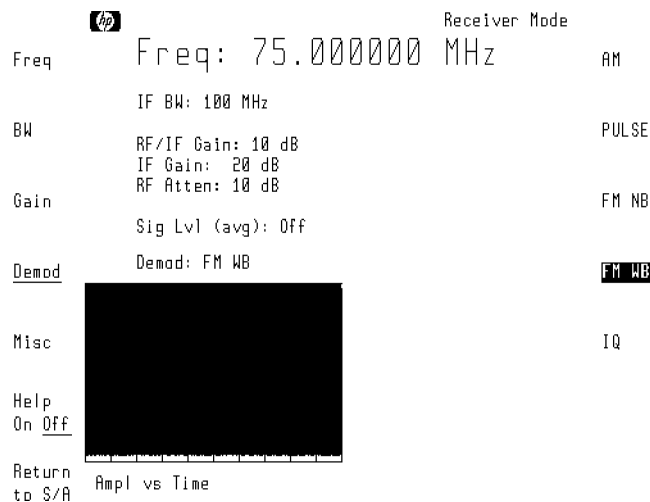

15. Press **DISPLAY**.
16. Press the left-side **Config Display** softkey.
17. Press **build window** and then **STACK 2 WINDOWS**.

Notice that when two windows are displayed, the receiver's small frequency versus time screen is not displayed.

18. Press **INSTR**.
19. Press left-side **70703A** softkey to select the oscilloscope as the active instrument window.

The oscilloscope's softkeys now appear.

20. Press **USER** to display additional oscilloscope softkeys.
21. Press **AUTO SCALE**.
22. Press the **MENU** key so that the left-side **Trigger** softkey is displayed.

You may need to press **Trigger** several times.

23. Use the front-panel knob to adjust the trigger level for a stable display.

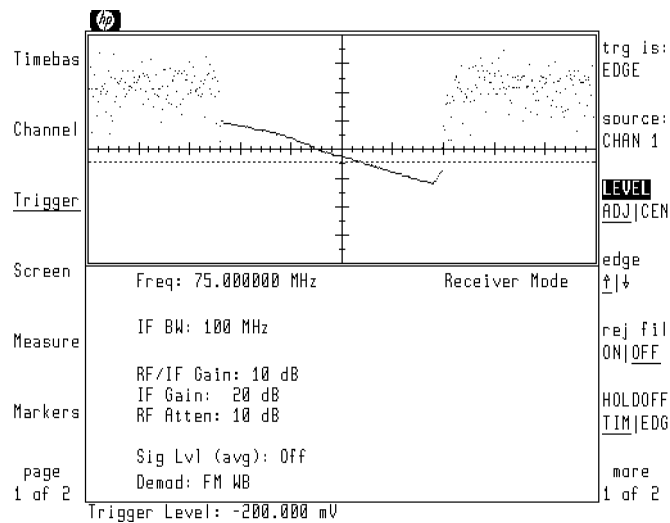

---

**Note** Due to the harmonic mixing process utilized in the receiver, frequency chirps may appear backwards. That is, negative sloped chirps may display showing positive slope and visa versa. This phenomena occurs in frequency bands where a minus mixing mode is used (100 Hz — 12.8 GHz). Because the HP 71910A's FM demodulator has a maximum bandwidth of 40 MHz, frequency chirps having a wider bandwidth will appear distorted.

---

24. If the sweep time needs to be adjusted, perform the following steps:
  - a. Press the **USER** key.
  - b. Press **SEC/DIV** and then use the **↓** and **↑** keys to change the sweep time.
  - c. Press the **MENU** key.
25. Press the left-side **Measure** softkey, and use the right-side menus to perform various measurements.
26. Press **more 1 of 4**, and select the desired measurements.

---

**Note**

The HP 70703A oscilloscope display shows amplitude versus time. To obtain frequency versus time, you must perform an appropriate calibration.

---

27. Press **INSTR** and then **70900B** to return to the receiver menus.
28. To search for another pulse signal to downconvert, do the following steps:
  - a. Press **USER**.
  - b. Press **Return to S/A**.
  - c. Press **FULL SPAN**.

## To characterize a wide-bandwidth digital transmission

This procedure shows how to display modulation constellations on an oscilloscope display. The figures in this procedure are of an HP 54602A oscilloscope. You can substitute any suitable oscilloscope.

---

**Note** In order to perform this procedure, the HP 71910A must have Option 004 installed.

---

1. Connect the signal to the HP 71910A's front-panel RF INPUT connector.
2. Connect the HP 70911A's front-panel I output to one of the oscilloscope's input channels.
3. Connect the HP 70911A's Q output to another oscilloscope input channel.
4. Repeat the following steps until the signal is displayed as shown in the following figure:
  - a. Press **PEAK SEARCH**.
  - b. Use the front-panel knob or **NEXT PEAK** key to place the displayed marker on the signal.
  - c. Press the left-side **Marker** softkey.
  - d. Press **-> CF** to center the signal.
  - e. Press **SPAN**, and use the **□** key to reduce the frequency span so that the main lobes of the signal are displayed.

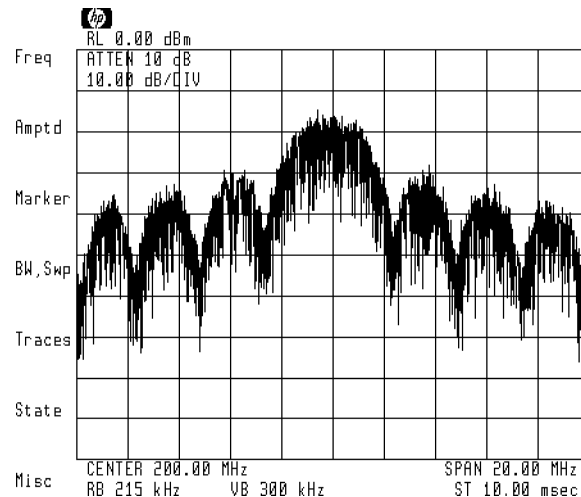

5. Press **USER** and then **RX\_MODE**.
6. Press the left-side **BW** softkey.

Notice that the **IF BW** function is automatically selected.
7. Press the **□** key several times to set the IF bandwidth to 100 MHz.
8. Press the left-side **Demod** softkey.



9. Press **IQ** and then **prev menu**.

---

**Note** The IQ output signals are always present. Pressing IQ displays a menu that allows you to adjust the gain, offset, and quadrature of the channels.

---

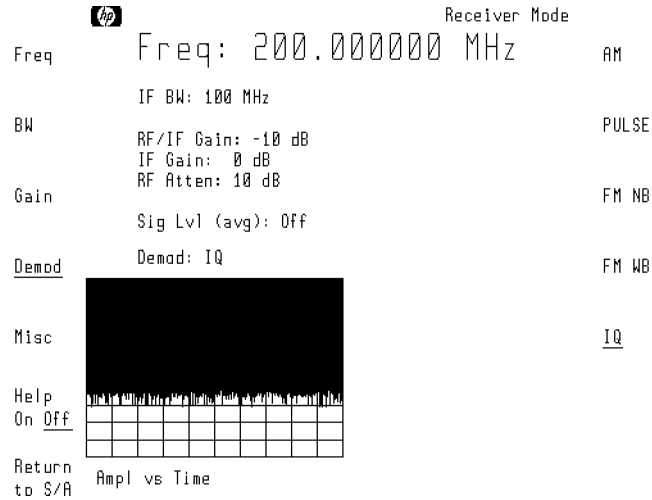

10. Configure the oscilloscope for XY operation. For example, on an HP 54602A oscilloscope, do the following steps:

- Press **Autoscale**.
- Press **Main Delayed**.
- Press **XY**.
- Adjust the horizontal and vertical positions so that the displayed pattern is centered.

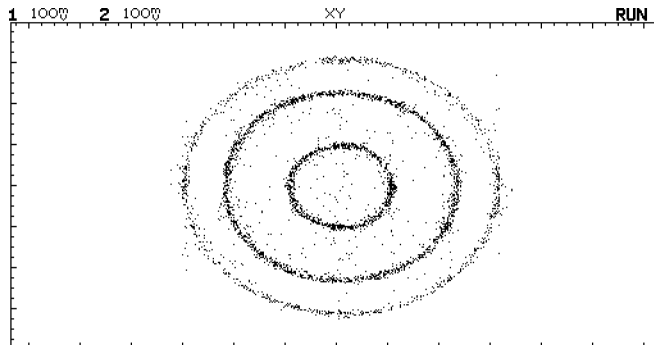

**Oscilloscope Display of 16 QAM Modulation**

---

**Note** The constellation spins because the input signal and the receiver are not tuned to the exact same frequency. In other words, their time bases are not locked.

---

11. To stop, or at least minimize the spin, do the following steps:

- a. On the HP 71910A, press the left-side **Freq** softkey.
- b. Press **CF STEP AutoMan**, **1**, and then **Hz**.
- c. Press **CENTER**.
- d. Press the **↑** or **↓** key repeatedly until the constellation pattern on the oscilloscope's display reaches its slowest spin rate.

This step may require 10 or 20 key presses. If the constellation's spinning does not slow down, the center frequency of the receiver may not be close enough to the carrier's frequency. Change the receiver's center frequency to be closer to the frequency of the carrier.

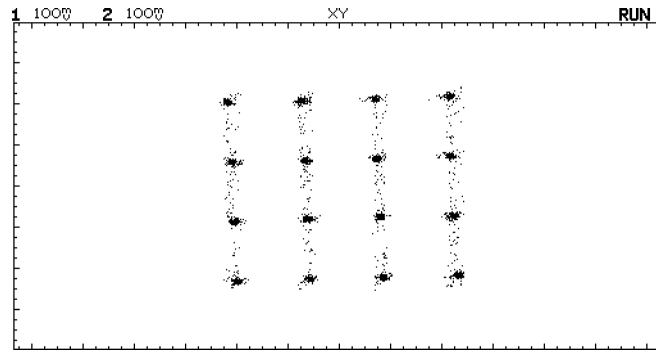

---

## Manually Collecting Signals

If the receiver personality becomes erased and a backup media is not available, manual operation without the personality is possible. This section describes manual operation. Chapter 1 contains a procedure for reinstalling the receiver personality.

### Disadvantage of manually collecting signals

The disadvantage of manually collecting signals is that you lose the following capabilities that are only available from the receiver menus:

- Ability to use Option 007 70 MHz IF channel filters.
- Access to the Option 005 FM discriminator selection.
- Ability to adjust Option 005 FM offset.
- Ability to adjust Option 004 IQ gain, offset, and quadrature.
- Display of average signal level.
- Access to the temperature compensation routine.
- Ability to change IF gain in 1 dB steps.

### Spectrum analyzer operation

As long as the resolution bandwidth (IF bandwidth) is 3 MHz or less, the spectrum analyzer operates normally. However, when a resolution bandwidth of 10 MHz or greater is selected, spectrum analyzer operation works within the following limitations:

- Logarithmic amplitude detection is no longer available.  
This limits the displayed dynamic range to approximately 35 dB. Although a linear detector is employed, signals are displayed using a logarithmic display format.
- Widest peak detection bandwidth is 3 MHz.
- Fastest digitizer rate in HP 70900B module is 80 kHz

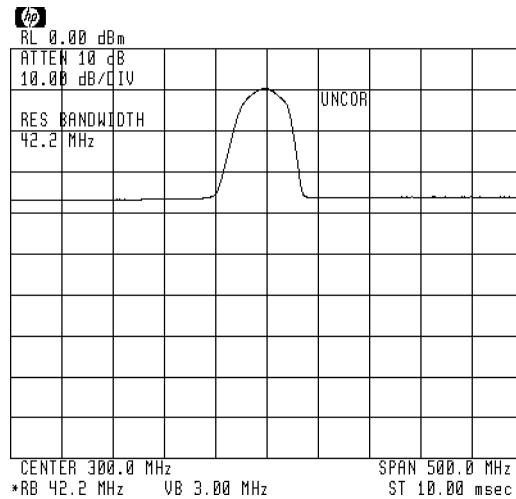

**Reduced Dynamic Range (IF BW  $\geq$  10 MHz)**

Use IF bandwidths less than or equal to 3 MHz to search for a signal. Then, when you've found the signal, manually switch to zero span and increase the bandwidth.

## Using Manual Mode

### 3 MHz Spectrum Analyzer

Although you can use the spectrum analyzer with resolution bandwidths selected above 3 MHz, this does **not** give you a wider bandwidth spectrum analyzer. For example, selecting a 100 MHz resolution bandwidth does not produce a 100 MHz spectrum analyzer. One limitation is that the instrument has no logarithmic amplifiers with bandwidths greater than 3 MHz. However, display can still show a logarithmic scale that is limited to 35 dB of dynamic range.

### Increasing Available Bandwidth

If you're downconverting signals between 2.7 and 26.5 GHz, you must turn off the microwave preselector to obtain the widest possible IF bandwidth. For example, if you select a 100 MHz IF bandwidth, but the microwave preselector is on, the effective bandwidth will be limited to 36 MHz. This is shown in the following table:

**HP 70911A 321.4 MHz IF Output**

Frequency	Approximate Widest Bandwidth
100 Hz—2.9 GHz	>48 MHz
2.7—26.5 GHz	
preselector on	>36 MHz <sup>1</sup>
preselector off	100 MHz

<sup>1</sup> The preselector's bandwidth increases at higher frequencies and is nearly 60 MHz at a 20 GHz center frequency.

### Demodulating AM signal

When demodulating AM signals, be sure that the video bandwidth is set no more than one third the value of the resolution bandwidth.

## Warning Messages

The following error messages can appear when using manual signal collection.

- *Possible compression*: IF step gain is in manual mode and is set to a value that may overload the spectrum analyzer's IF circuits.
- *UNCAL*: Indicates one of the following problems exists:
  - An IF bandwidth is selected that is wider than the available bandwidth of the instrument's RF front end. Refer to the table shown above. For example, this message appears if a 100 MHz bandwidth is selected while the preselector is on.
  - A video bandwidth wider than 3 MHz is selected. This is because the bandwidth is being limited by a digitizer which is used to display the signal on the screen. Its peak detector bandwidth is approximately 3 MHz.
- *UNCOR*: An IF bandwidth is set greater than 40 MHz. This occurs because the amplitude calibration data is not applied for bandwidths wider than 40 MHz. It is applied to bandwidths up to 30 MHz and is interpolated for bandwidths between 30 MHz and 40 MHz.
- *usable RBW limited*: Indicates that an IF bandwidth is selected that is wider than the available bandwidth of the instrument's RF front end. Refer to the table shown above. For example, this message appears if a 100 MHz bandwidth is selected while the preselector is on.

### To manually enter collection receiver mode

1. Press the left-side **BW, Swp** softkey.
2. Press **RES BW AutoMan**, and enter an IF bandwidth of 3 MHz or less.
3. Use the normal spectrum analyzer functions to locate a signal.
4. Press the left-side **Marker** softkey.
5. Press **MKR NRM On Off** so that **On** is underlined.
6. Place a marker on the signal's peak.
7. Press **SIG TRK On Off** so that **On** is underlined.
8. Press **(SPAN)**, and enter a value of 10 MHz.  
Automatically tracks a CW signal and keeps it centered as the span is reduced.
9. Press **SIG TRK On Off** so that **Off** is underlined.
10. Press **(SPAN)**, and enter a value of 0 Hz.
11. Maximum bandwidth is achieved when the spectrum analyzer's microwave preselector is bypassed. To bypass the preselector, perform the following steps:
  - a. Press the left-side **Freq** softkey.
  - b. Press **MORE 1 of 3** and then **preselect**.
  - c. Press **PRESEL On Off** so that **Off** is underlined.
12. Press the left-side **BW, Swp** softkey.
13. Press **RES BW AutoMan**, and enter an IF bandwidth greater than 3 MHz.
14. Signals are displayed using a logarithmic scale. To switch to a linear scale, perform the following steps:
  - a. Press the left-side **Amptd** softkey.
  - b. Press **LINEAR**.
15. To select the IF gain, perform the following steps:
  - a. Press the left-side **Amptd** softkey.
  - b. Press **MORE 1 of 4**, **MORE 2 of 4**, and then **MORE 3 of 4**.
  - c. Press **STP GAIN AutoMan**, and change the amount of step gain that is applied.
16. The downconverted signal is now available at the HP 70911A module's rear-panel 321.4 MHz OUT connector.

## To search for and collect a pulsed RF signal

1. Connect the signal to the HP 71910A's front-panel RF INPUT connector.
2. On the HP 71910A, press **PEAK SEARCH**, and position the marker on the signal's peak.

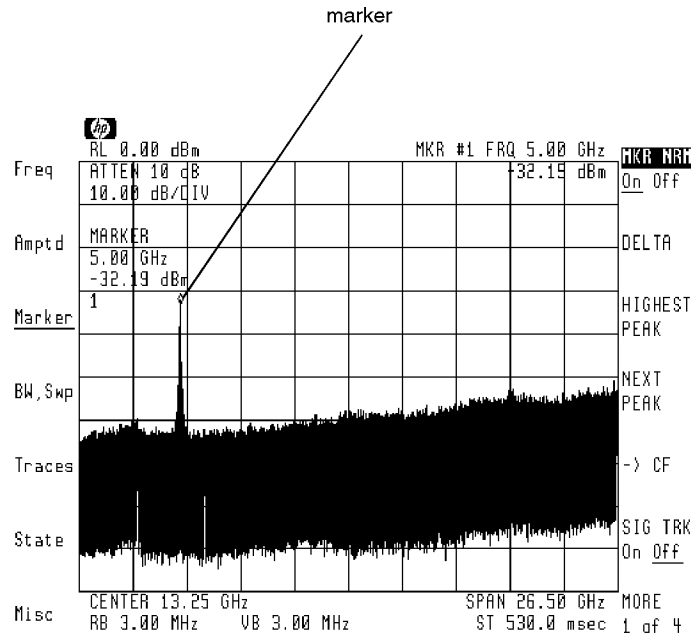

displayc

3. Press **SIG TRK On Off** so that **On** is underlined.
4. Press **SPAN**, and enter a value of 10 MHz.  
Automatically tracks signal and keep it centered as the span is reduced.
5. Press **SIG TRK On Off** so that **Off** is underlined.
6. Press **SPAN**, and enter a value of 0 Hz.
7. Press the left-side **BW, Swp** softkey.
8. Press **RES BW AutoMan**, and enter a 100 MHz resolution bandwidth.

The resolution bandwidth function is the IF bandwidth.

---

**Note** The UNCOR and UNCAL messages appear on the display indicating that the displayed video is not corrected. UNCOR indicates that the resolution bandwidth is set to a value whose center frequency is not corrected by the calibration routine. UNCAL indicates that the video bandwidth is set wider than 3 MHz or that the resolution bandwidth is limited by the preselector filter.

---



	RL 0.00 dBm		MKR #1 SWT 5.000 msec		PRESEL
Freq	ATTEN 10 dB				PEAK
	10.00 dB/DIV				
Amptd	RES BANDWIDTH		UNCOR	UNCAL	PRESEL
	100 MHz				DAC
Marker					PRESEL
					HYS
BW, SWP					PRESEL
					On Off
Traces					
State					pre sel
					center
Misc	CENTER 5.001 075 001 GHz			SPAN 0 Hz	prev
	*RB 100 MHz	VB 100 MHz		ST 10.00 msec	menu

### UNCOR and UNCAL Messages

9. If the center frequency of the signal being downconverted is above 2.7 GHz, you can increase the available bandwidth by bypassing the preselector. Perform the following steps:
  - a. Press the left-side **State** softkey.
  - b. Press **preselect**.
  - c. Press **PRESEL On Off** so that **Off** is underlined.
10. If you need to change the IF gain, perform the following steps:
  - a. Press the left-side **Amptd** softkey.
  - b. Press **MORE 1 of 4**, **MORE 2 of 4**, and then **MORE 3 of 4**.
  - c. Press **STPGAIN AutoMan** and use the **↑** and **↓** keys to change the step gain.
11. The following output signals are available for characterizing:
  - IF signals at the HP 70911A module's rear panel.
  - AM and pulse demodulation signals at the HP 70911A module's front-panel VIDEO connector.
  - On Option 004 instruments, analog IQ signals are available at the HP 70911A module's front-panel I and Q connectors.
  - On Option 005 instruments, FM demodulation is available at the HP 70911A module's front-panel FM connector.

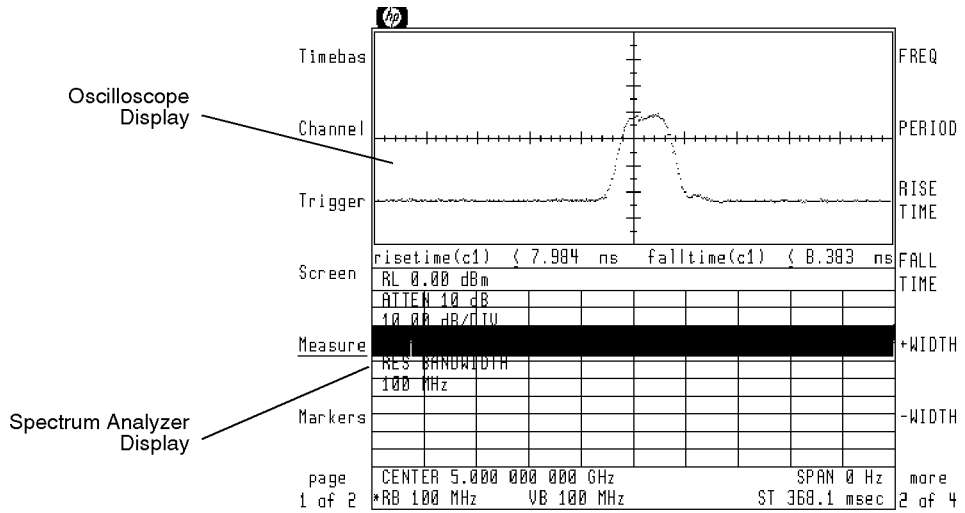

**HP 70703A Oscilloscope Display of VIDEO Output**

---

**Note** Refer to “Controlling System Configuration” in this chapter for information on how to simultaneously display two instruments as shown in the above figure.

---

## Using a Preamplifier

An HP 70620B or HP 70621A preamplifier provides approximately 30 dB of gain to the input signal. (The actual gain varies slightly with the center frequency setting.) In receiver mode, the actual preamp gain is shown in the **RF/IF Gain** annotation; it is the numerical value that is surrounded by brackets and is shown in the following figure as [33.3]. Remember that the **RF/IF Gain** value represents the amount of signal gain from the preamplifier's front-panel **RF INPUT** connector to the HP 70911A's rear-panel 70 MHz connector. This is displayed as 8.3 dB in the following figure.

The **RF/IF Gain** value is calculated as shown in the following equation:

$$RF/IF\ Gain = preamp\ gain + IF\ gain - RF\ attenuation$$

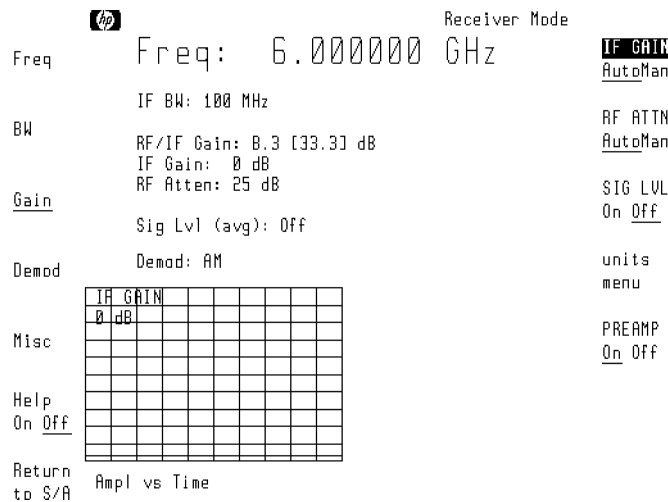

**The RF/IF Gain Annotation**

The HP 70620B preamp can be switched on or off. When the preamp is turned off, there is a slight loss (approximately 1 dB) through the preamp. This loss is displayed with the **RF/IF Gain** values as a negative value. Before switching to receiver mode, be sure to set the reference level so that the signal is at the top of the display.

**Note** Compression occurs whenever signals that are  $-30$  dBm or greater are input to the preamplifier. Because this compression occurs before the RF attenuator, changing the RF attenuation or reference level values will not solve this problem.

### To use the HP 70620B preamp

1. Install the HP 70620B into the mainframe as described in Chapter 1.
2. Perform a front-panel calibration as described in this chapter's first section.
3. Press **MENU** and then the left-side **State** softkey.
4. Press **select input**.
5. Press **IN 1 70620B** to select HP 70620B preamplifier's RF INPUT.
6. Press **prev menu**.
7. Press **MORE 1 of 4** and then **preamp control**.
8. Press **PREAMP On Off** so that **On** is underlined.

### To turn off the preamp in receiver mode

---

**Note** The **PREAMP On Off** softkey does not operate unless the HP 70620B's RF INPUT connector is first selected. This is accomplished using the **MENU** menus as described in "To use the HP 70620B preamp" above.

---

**Note** If the reference level is approximately  $-40$  dBm or higher, turning the preamplifier on adds more RF attenuation to the HP 70910A RF section.

---

1. Press the left-side **Gain** softkey.
2. Press **PREAMP On Off** so that **Off** is underlined.

---

## Extending the Frequency Range with External Mixers

By adding an HP 11974 series preselected millimeter mixer, the HP 71910A receiver can be tuned to signals that are above 26.5 GHz. These mixers extend operation up to 75 GHz. The following table shows the HP 11974 mixers with their frequency ranges.

**External Mixers**

Mixer	Frequency Range
HP 11974A	26.5—40 GHz
HP 11974Q	33—50 GHz
HP 11974U	40—60 GHz
HP 11974V	50—75 GHz

Normally, only one external mixer can be connected to the HP 71910A. To add more external mixers, you must install an HP 70907B external mixer interface module. Refer to the *HP 70900B User's Guide for HP 70900B Instruments* for more information on external mixer operation.

## Controlling System Configuration

This section provides instructions for system configuration tasks that include saving receiver states, blanking the screen, and writing titles on the display. You can also simultaneously display several MMS instrument screens on the HP 70004A display.

Receiver states greatly reduce the time required to set up measurements. Simply configure the receiver for a particular measurement that you repeatedly perform, then save the settings as a receiver state. Whenever this state is recalled, the previous receiver settings are restored.

At times you may want to blank the screen for security reasons. This can be accomplished from within the receiver mode.

Writing titles on the screen is easy using the title feature. Titles are especially useful when identifying plotter and printer copies. Because the titles are part of the annotation, be sure that the annotation is visible before attempting to create a title. Annotation is turned on or off with the normal spectrum analyzer menus.

```

Receiver Mode
Freq      Freq: 6.000000 GHz      DISPLAY
                                         On Off
                                         save &
                                         recall
BW        IF BW: 10 MHz
          RF/IF Gain: 10 dB
          IF Gain: 20 dB
          RF Atten: 10 dB
Gain      Sig Lvl (avg): Off      70911
                                         OPTIONS
Demod     Demod: AM              RECEIVER
                                         VERSION
Misc      [Grid]                temp
                                         compens
Help      [Grid]
On Off    [Grid]
Return   Ampl vs Time
to S/A

```

## To save a receiver state

During this procedure, you'll be asked to enter a name for the saved receiver state. If you have a HIL accessory keyboard, entering the text is much easier. The keyboard plugs into an HP-HIL connector on the front-panel of HP 70004A displays. The keyboard and associated cable have the following part numbers:

HIL keyboard .....HP 46021A  
keyboard cable .....46020-60001

1. Press **USER** and then **RX\_MODE** to start the receiver collection personality.
2. Press the left-side **Misc** softkey.
3. Press **MORE 1 of 3**.
4. Press **save & recall**.
5. Press one of the following softkeys to select the memory where the receiver state will be stored:
  - **INTRNL MEMORY** indicates the instrument's internal memory.
  - **HP-MSIB CARD** indicates a memory card in the optical spectrum analyzer's front-panel card slot.

Remember to insert the card before pressing **HP-MSIB CARD**. If **2053 Storage device error** is displayed, either the card is missing, the card's write-protect switch is in the **SAFE** position, or the card's HP-MSIB address is incorrectly listed. The HP-MSIB address for the card is the same address as the display's HP-IB address and is normally set to 4. If the address is not correct, enter the correct address using the numeric keypad.
  - **HPIB DISK** indicates an external HP-IB disk drive. Refer to Chapter 1 for information on connecting the disk drive.
6. Enter a title for the receiver state. If you do not have a keyboard, use the following instructions to create the title text:
  - Turn the front-panel knob to select a character.
  - Press the **▼** and **▲** keys (beneath the front-panel knob) to move the command-entry cursor.
  - Press **SELECT CHAR** to enter a character at the character-select cursor.
  - Press the numeric keypad to enter numbers or a minus sign.
  - Press **SPACE** to add a space character.
  - The **INSERT or . . .** softkey determines the action of the **SELECT CHAR** softkey. Choices are **INSERT** a character, **REPLACE** an existing character, or **DELETE** a character.
  - Use the **CLEAR TO END** softkey to remove characters from the command-entry cursor to the end of the command.
  - The space character is located after the **Z** character on the display.

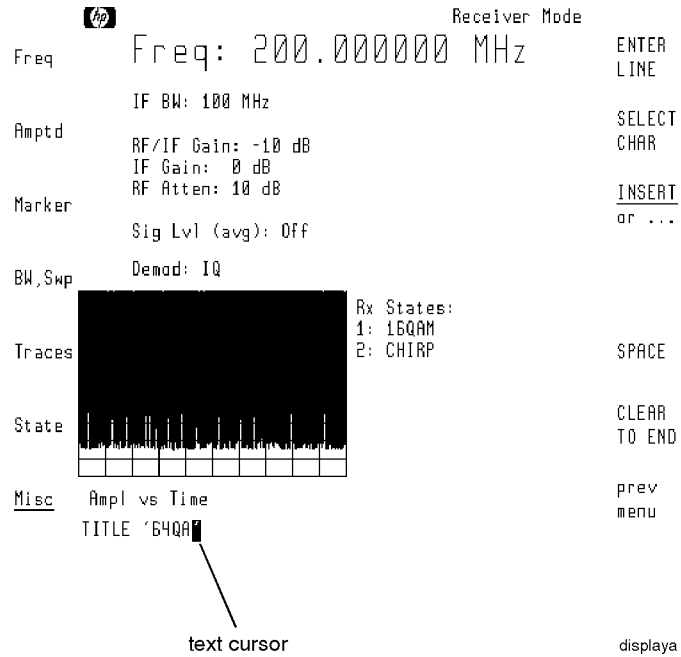

7. Press the **ENTER LINE** softkey to place the title on the screen.
8. Press **prev menu**.
9. Press **SAVE RX STATE**, and use the numeric keypad to enter a number for the file.



## To recall or delete a receiver state

1. Press **USER** and then **RX\_MODE** to start the receiver collection personality.
2. Press the left-side **Misc** softkey.
3. Press **MORE 1 of 3**.
4. Press **save & recall**.
5. Press a softkey to select the memory where the receiver state will be stored:
  - **INTRNL MEMORY** indicates the instrument's internal memory.
  - **HP-MSIB CARD** indicates a memory card in the optical spectrum analyzer's front-panel card slot.

Remember to insert the card before pressing **HP-MSIB CARD**. If **2053 Storage device error** is displayed, either the card is missing, the card's write-protect switch is in the **SAFE** position, or the card's HP-MSIB address is incorrectly listed. The HP-MSIB address for the card is the same address as the display's HP-IB address and is normally set to 4. If the address is not correct, enter the correct address using the numeric keypad.
  - **HPIB DISK** indicates an external HP-IB disk drive. Refer to Chapter 1 for information on connecting the disk drive.
6. Perform one of the following tasks:
  - To recall a receiver state, press **RCL RX STATE**, and enter the number that identifies the file.
  - To delete a receiver state, press **DEL RX STATE**, and enter the number that identifies the file. Then, press **ENTER**.

### To view two instrument windows

This procedure displays two instrument windows on the HP 70004A's display. This is especially useful if you are using your HP 71910A with an HP 70703A Digitizing Oscilloscope.

1. Press the **DISPLAY** key.
2. Press the left-side **Config Display** softkey.
3. Press **build window** and then **STACK 2 WINDOWS**.
4. Press **INSTR**.
5. Press the left-side softkey that is next to the instrument window that you want to select.

For example, to select the HP 71910A, press **70900B**. To select the HP 70703A, press **70703A**. The instrument's softkeys will now appear.

6. To switch control to the next instrument window, press **INSTR** and then the appropriate softkey.

### To blank the display

1. Press the left-side **Misc** softkey.
2. Press **DISPLAY On Off** so that **On** is underlined.

## To write a title on the screen

---

**Note** If you have a HIL keyboard, entering the text is much easier. The keyboard plugs into an HP-HIL connector on the front-panel of HP 70004A displays. The keyboard and associated cable have the following part numbers:

HIL keyboard .....	HP 46021A
keyboard cable .....	46020-60001

---

1. Press the left-side **Misc** softkey to enter the Miscellaneous menu.
2. Press **save & recall**.
3. Press the **TITLE** softkey to enter the Title menu.
4. Use the following instructions to create the title text:
  - Turn the front-panel knob to select a character.
  - Press the **▼** and **▲** keys (beneath the front-panel knob) to move the command-entry cursor.
  - Press **SELECT CHAR** to enter a character at the character-select cursor.
  - Press the numeric keypad to enter numbers or a minus sign.
  - Press **SPACE** to add a space character.
  - The **INSERT or . . .** softkey determines the action of the **SELECT CHAR** softkey. Choices are INSERT a character, REPLACE an existing character, or DELETE a character.
  - Use the **CLEAR TO END** softkey to remove characters from the command-entry cursor to the end of the command.
  - The space character is located after the **Z** character on the display.
5. Press the **ENTER LINE** softkey to place the title on the screen.

```

Receiver Mode
Freq: 200.000000 MHz
IF BW: 100 MHz
RF/IF Gain: -10 dB
IF Gain: 0 dB
RF Atten: 10 dB
Sig Lvl (avg): Off
Demod: IQ
Rx States:
1: 16QAM
2: CHIRP
Ampl vs Time
TITLE '64QAM'

```

hp

ENTER LINE

SELECT CHAR

INSERT or ...

SPACE

CLEAR TO END

prev menu

displaya

text cursor

# Block Diagrams

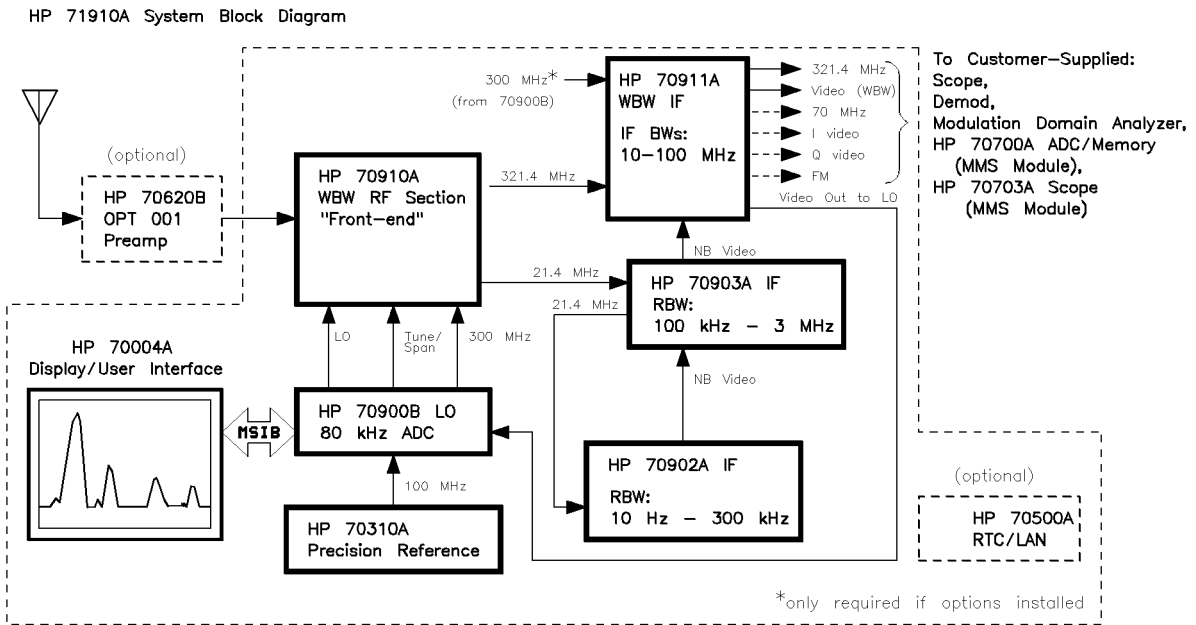

HP 71910A System Block Diagram

HP 70910A RF Section ("Front-End")

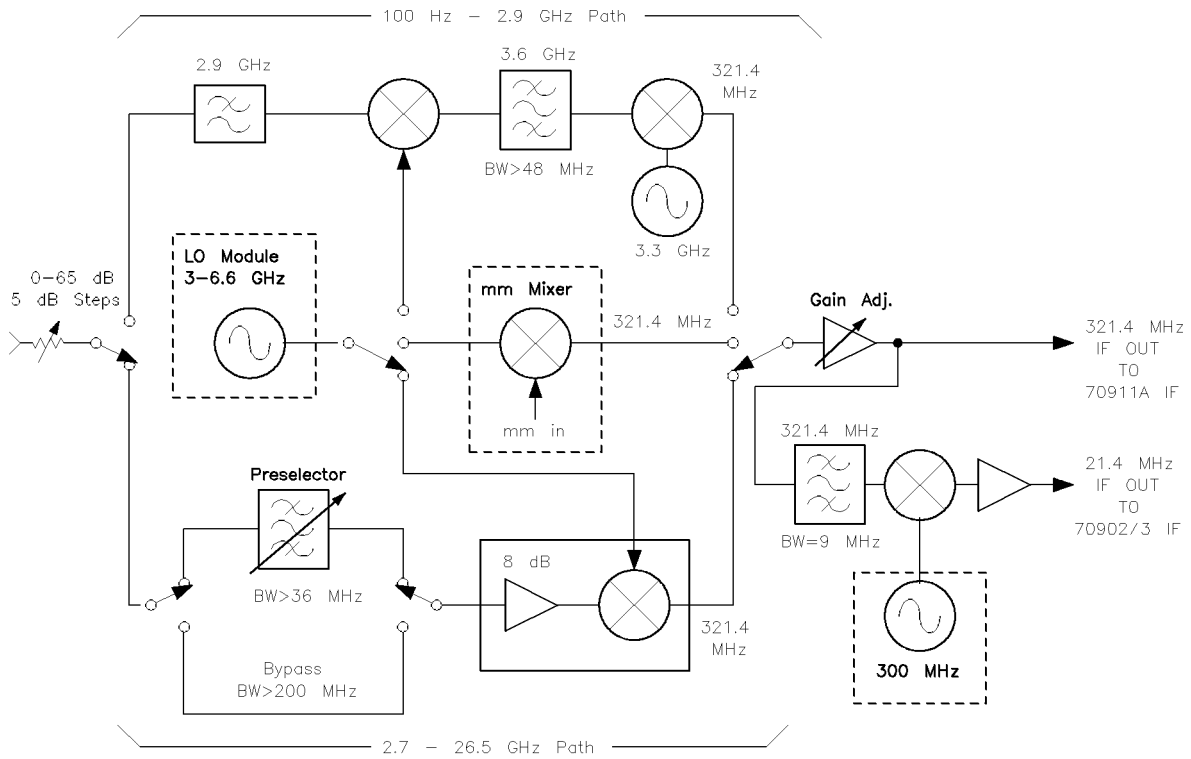

HP 70910A RF Section Block Diagram

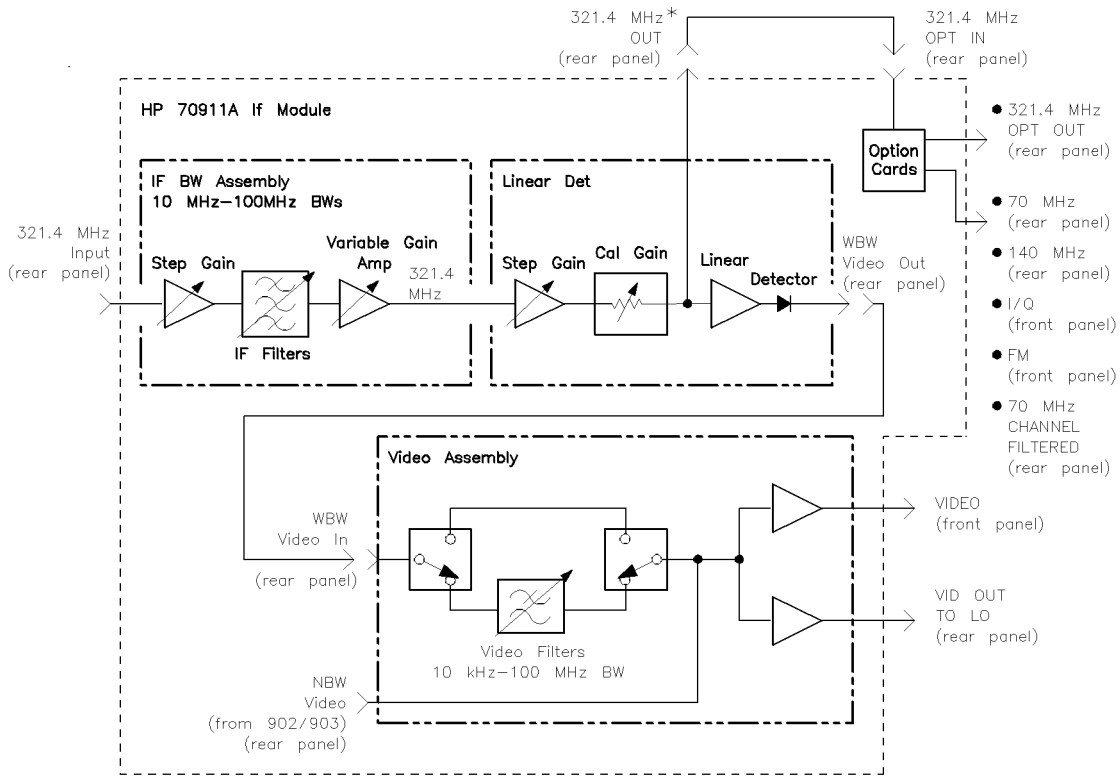

\* To external processing device or to HP 70911 internal options:

- Opt 001: 70 MHz IF
- Opt 002: 140 MHz IF
- Opt 004: analog I/Q
- Opt 005: FM
- Opt 007: channel filters

ifbd

**HP 70911A IF Module Block Diagram**

---

## If You Have a Problem

Your wide-bandwidth surveillance receiver is built to provide dependable operation. It is unlikely you will experience a problem, but in the event something goes wrong, this section provides solutions to common problems.

Error messages can be displayed for a variety of reasons. Most messages indicate a harmless situation. For example, they may simply indicate that you attempted to enter a value that was out of a particular function's range. However, if an error message remains after pressing several keys, it may indicate a more serious problem. Refer to Chapter 9 for a list of error messages.



## If **UNCOR** is displayed

UNCOR indicates that the displayed amplitude data is not corrected.

---

**Note** The information provided in this section refers to operating the HP 71910A in manual mode versus using the receiver personality.

---

### Symptoms

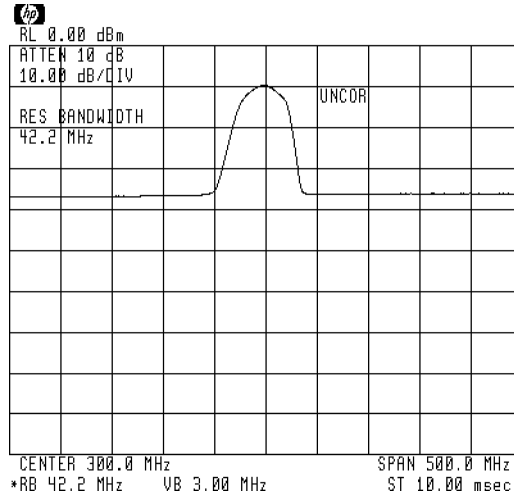

### To solve this problem

Ignore this message when collecting signals.

This message refers to *displayed* data. **UNCOR** is displayed when the HP 71910A is in manual mode and the resolution bandwidth is set to a value greater than 40 MHz. This is because the calibration routine does not correct for bandwidths that are wider than 40 MHz.

---

**Note** The display shown above shows the 30 dB amplitude range of the linear detector. A logarithmic amplifier is not present for IF bandwidths of 10 MHz to 100 MHz. Use resolution bandwidths of 3 MHz or less for signal searches since a logarithmic amplifier is present for those bandwidths.

---

## If UNCAL and Usable RBW limited is displayed

UNCAL and Usable RBW limited is displayed indicates that the RF module is limiting the available bandwidth.

---

**Note** The information provided in this section refers to operating the HP 71910A in manual mode versus using the receiver personality.

---

### Symptoms

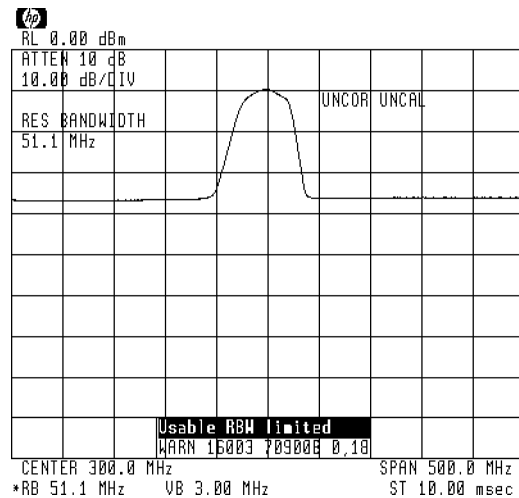

### To solve this problem

- If the signal is in the microwave bands (2.7 GHz to 26.5 GHz), and the preselector is on, the maximum bandwidth is limited to greater than 36 MHz. Turn the preselector off (bypass mode) using the procedure contained in this section.
- If the signal is in the RF bands (100 Hz to 2.9 GHz) the maximum bandwidth is approximately 48 MHz. There is no bypass for this frequency range. So, UNCAL will appear.

### To bypass the preselector

When the preselector is on, its bandwidth depends on the center frequency. The bandwidth increases as the frequency increases. At 20 GHz, the bandwidth is greater than 50 MHz.

1. On the HP 71910A, press the left-side **State** softkey.
2. Press **preselect**.
3. Press **PRESEL On Off** so that **Off** is underlined.

## If UNCAL and Usable VBW limited is displayed

This message only refers to *displayed* data and not the HP 71910A's IF, VIDEO, FM, or IQ outputs. The message appears when the video bandwidth is set greater than the 3 MHz video bandwidth limit of the HP 70900B module's peak detector.

---

**Note** The information provided in this section refers to operating the HP 71910A in manual mode versus using the receiver personality.

---

### Symptoms

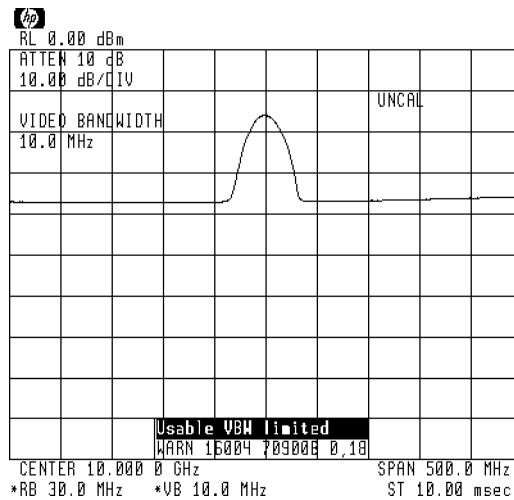

### To solve this problem

Ignore this message when collecting signals. Realize that the spectrum analyzer's display is uncalibrated. This is particularly true for signals such as pulsed RF which result in desensitized amplitude displays.

## If Possible compression is displayed

Possible compression indicates that the signal is overdriving the IF and is being compressed.

---

**Note** The information provided in this section refers to operating the HP 71910A in manual mode versus using the receiver personality.

---

## Symptoms

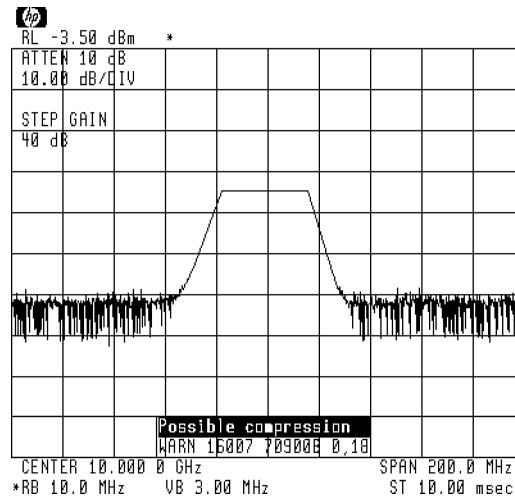

## To solve this problem

1. Press the left-side **Amptd** softkey.
2. Press **MORE 1 of 4**, **MORE 2 of 4**, and then **MORE 3 of 4**.
3. Do one of the following:
  - Press **STPGAIN AutoMan** so that **Auto** is underlined.
  - Press **STPGAIN AutoMan** and reduce the IF step gain.

## If the PREAMP On Off softkey doesn't work

---

**Note** The information provided in this section refers to operating the HP 71910A with an HP 70620B or HP 70621A preamplifier.

---

### Symptoms

Pressing the **PREAMP On Off** softkey does not toggle the softkey highlighting between the **On** and **Off** conditions.

### To solve this problem

The preamplifier's RF INPUT connector must first be selected.

1. Press **(MENU)** and then the left-side **State** softkey.
2. Press **select input**.

---

**CAUTION** The following step presets the receiver's state which causes many of the measurement settings to change.

---

3. Press **IN 1 70620B** to select HP 70620B preamplifier's RF INPUT.
4. If you are using the receiver personality, perform the following steps:
  - a. Press **(USER)**.
  - b. Press the left-side **Gain** softkey.
  - c. Press **PREAMP On Off** to turn the HP 70620B preamp on or off.
5. If you are not using the receiver personality, perform the following steps:
  - a. Press the left-side **State** softkey.
  - b. Press **MORE 1 of 4** and then **preamp control**.
  - c. Press **PREAMP On Off** to turn the HP 70620B preamp on or off.

## If there is a frequency shift in an HP 70911A output

### Symptoms

- An HP 70911A IF, FM, or IQ output is frequency shifted.
- A displayed constellation spins when resolution bandwidth of 3 MHz or lower is selected.

When simultaneously analyzing an IF output of one of the spectrum analyzer IF modules ( HP 70902A or HP 70903A) and an IF, FM, or IQ output from the HP 70911A ultra-wide bandwidth IF module, you may notice a slight frequency shift in the output of the HP 70911A outputs. This occurs when a resolution bandwidth of 3 MHz or lower is selected and when the calibration has been run (that is, no UNCOR message appears on the screen). For example, this frequency shift may be evident when viewing a constellation display using the analog IQ outputs of the HP 70911A. The constellation may be fixed (not rotating) when an IF bandwidth of 10 MHz or greater is selected. However, when a resolution bandwidth of 3 MHz or lower is selected, the constellation starts spinning. The frequency shift only occurs when bandwidths of 3 MHz or lower are selected.

### To solve this problem

1. Press **MENU**.
2. Press the left-side **Amptd** softkey.
3. Press **MORE 1 of 4**, **cal menu**, and then **cal enable**.
4. Press **RBW FRQ** so that it is off.

The UNCOR screen annotation will appear as long as the **RBW FRQ** is off.

## Programming

---

This chapter describes operation via a remote computer. The topics covered in this chapter are listed below:

### Contents

Getting Started .....	4-2
HP BASIC Programming Example .....	4-4
Communicating with the Receiver .....	4-5
Transferring Data to the Computer .....	4-7
Monitoring System Operation .....	4-8

---

## Getting Started

The HP 71910A Wide Bandwidth Surveillance Receiver has a rich set of programming commands. These commands are divided into two groups: those that control spectrum analyzer features and those that control features provided by the receiver personality. To learn about the spectrum analyzer commands, refer to the *HP 70900B Programmer's Guide for HP 70900B Instruments*. To learn about receiver personality commands, refer to Chapter 8 in this book.

Use the spectrum analyzer commands for signal searches and the receiver commands for signal collection. For example, perform basic spectrum analyzer search tasks such as setting the start and stop frequencies and using markers to search for signals. Then, use the receiver personality commands to perform collection tasks such as selecting signal demodulation (AM, PULSE, FM narrowband, FM wideband, and IQ) and Option 007 IF channel filters.

The spectrum analyzer commands and the receiver personality commands are both sent to the HP-IB address of the HP 70900B module. This address is equal to the column address of the HP 70900B module which has a default value of 18.

### Initialize the personality

Before using any receiver personality commands, initialize the personality by sending the `RXRMT INIT` command. It is recommended that the personality not be running when sending the `RXRMT INIT` command or using any of the remote commands documented in this chapter; these commands execute faster if the personality is *not* manually running. This is due to the time required to update the display.

---

**Note** Before you can use any of the receiver personality commands, you must initialize the personality by sending the `RXRMT INIT` command.

---

### Important spectrum analyzer commands

The following is a list of commands documented in the *HP 70900B Programmer's Guide for HP 70900B Instruments* that are specific to receiver operation:

- `CPLDET`: Controls the coupling between the logarithmic scale (LG command), linear scale (LN command) and the detector used for trace data (See `DETSEL` below).
- `DETSEL`: Selects the hardware detector used for trace data (logarithmic or linear).
- `PC`: Perform preselector centering.
- `PCDELTA`: Adjust the delta value for performing preselector centering.
- `PRSENABLE`: Turns the preselector on and off.
- `SG`: Controls the step gain in the signal path.
- `SS`: Sets the center frequency step size.



## To connect the equipment

The following procedure describes how to connect your equipment for remote operation.

1. Connect the computer, MMS mainframe, and other peripherals with HP-IB cables.
2. After the HP-IB cables are installed, reset all instruments connected to the bus. If you are not sure how to reset a device, switch its line power off, then on, to reset it.
3. Check the column address of the HP 70900B module on the address map. Use this value as the HP-IB address to send receiver commands.

To view the address map, press the **DISPLAY** key on the display front-panel, then press the **Address Map** softkey.

---

## HP BASIC Programming Example

The following HP BASIC example illustrates some simple techniques used to search for a signal, initialize the receiver personality, and collect the data.

1	ASSIGN @Rx to 718	<i>Assign the HP 70900B's HP-IB address.</i>
2	CLEAR @Rx	
3	OUTPUT @Rx;"IP;"	<i>Preset the instrument.</i>
4	OUTPUT @Rx;"SNGLS;"	<i>Select single sweeps.</i>
5	OUTPUT @Rx;"FA1GHZ;FB2GHZ;"	<i>Set frequency range.</i>
6	OUTPUT @Rx;"TS;"	<i>Take a single sweep.</i>
7	OUTPUT @Rx;"MKPK HI;MKCF;"	<i>Move highest peak to center of screen.</i>
8	OUTPUT @Rx;"RXRMT INIT;"	<i>Initialize receiver personality.</i>
9	OUTPUT @Rx;"RXRMT CHANPATH 70E6,5E6;"	<i>Select Option 007 5 MHz filter in 70 MHz IF path.</i>
10	OUTPUT @Rx;"RXRMT DEMOD FM;"	<i>Select FM demodulation.</i>
11	OUTPUT @Rx;"RXRMT SAVERX 1;"	<i>Save receiver settings for later recall.</i>

---

## Communicating with the Receiver

This section develops some fundamental techniques for controlling and obtaining reliable measurement results using HP BASIC. It is important to understand how messages are communicated to the receiver; therefore, enter and output statements and command syntax discussed in this chapter should be understood before proceeding. HP BASIC is used for all examples in this manual.

### Initial Commands

Programs should begin with a series of HP BASIC statements and receiver commands that form a good starting point for measurements. The following example shows how to initialize the receiver.

```
10  ASSIGN @Rx to 718
20  CLEAR @Rx
30  OUTPUT @Rx;"IP;"
```

The **ASSIGN** statement creates an I/O path name and assigns that name to an I/O device. In the example above, the I/O path name is **@Rx**. It is assigned to the device at interface select code 7 (the HP-IB interface), and at HP-IB address 18.

Using the **ASSIGN** statement in a program makes it easier to change the address of the receiver. In applications where speed is important, using **ASSIGN** can also improve program performance.

**CLEAR** is an HP BASIC statement that clears the input buffer, the output buffer, and the command parser of the specified instrument, so that it is ready for operation. This command may be used to clear devices on the bus singly or in unison. It is often desirable to clear only one instrument so that other instruments on the bus are not affected.

- To clear only the receiver, **CLEAR @Rx** should be used.
- To clear all devices at select code 7, **CLEAR 7** must be used.

**IP**, the instrument preset command, presets all of the parameters of the spectrum analyzer and is a good starting point for all measurement processes.

### Executing Remote Commands

The computer communicates with the receiver on the Hewlett-Packard Interface Bus (HP-IB), using HP BASIC **OUTPUT** and **ENTER** statements. An **OUTPUT** statement tells the computer to send a message to the receiver (HP 70900B LO module). For example, executing the statement below selects the receiver's AM demodulation:

```
OUTPUT 718;"RXRMT DEMOD,AM;"
```

An **ENTER** statement used in conjunction with a receiver query returns information to the computer. To return the demodulation selection to the computer, first form a query by adding a question mark (?) to the command:

```
OUTPUT 718;"RXRMT DEMOD?;"
```

Next, the **ENTER** statement is used to assign the returned value to a variable in the computer: The returned value above is placed in the variable named "demod". The variable may be printed, stored, or used for other computer functions.

```
ENTER 718; demod$
```

## Local and Remote Control

Whenever the receiver is remotely addressed, the display front-panel softkeys are disabled and blanked. Pressing the **LOCAL** key or executing the HP BASIC statement **LOCAL** reactivates operation of the softkeys.

The front-panel indicators on the HP 71910A receiver light under the following conditions when the HP-IB interface is used:

- When the receiver is addressed, the RMT indicator lights.
- When the receiver receives information, the LSN indicator lights.
- When the receiver sends information, the TLK indicator lights.
- When a measurement event (for example, end of the sweep) has occurred and the receiver is requesting computer attention, the SRQ indicator lights (provided that the service-request mask is set to allow SRQ on end-of-sweep).

---

## Transferring Data to the Computer

The receiver returns information as decimal values in fundamental units shown in the following table. The receiver also applies these units to data received from the computer which do not explicitly specify units.

**Units for Returned Data**

<b>Measured Data</b>	<b>Fundamental Unit</b>
Amplitude	dBm, watt
Power	dBm, watt
Ratio	dB
Responsivity	volt/watt

Use the AUNITS (amplitude units) command is used to select the desired unit. The AUNITS command can either specify a single unit to be used for all power and amplitude information, or it can be set to automatically select the units, based on certain measurement settings.

Refer to the description of the AUNITS command in the *HP 70900B Programmer's Guide for HP 70900B Instruments* for more information.

---

## Monitoring System Operation

The programming techniques discussed so far describe communication between the receiver and the computer, where the sequence of all data transfer is controlled by a computer program. This section describes how the receiver can interrupt computer operation upon attaining a particular state.

The interrupting process is called a service request. Service requests have many applications. They facilitate economical use of computer-processing time when the receiver is part of a large measurement system. For example, after the computer initiates a receiver measurement, the computer can make calculations or control other devices via HP-IB while the receiver is measuring. When the receiver is through, it signals the computer with a service request. The computer's service-request subprogram then determines what the computer will do next. Service requests can also be used to report errors.

### Interrupt Process

The interrupt process begins when the receiver “requests” attention by setting the HP-IB service-request line (SRQ) true. The computer must be programmed to respond to this event. Typically, the computer is programmed to interrupt normal program execution and call a user-specified subroutine when the service request occurs. This subroutine must determine which instrument(s) on HP-IB caused the service request. Then, it may be necessary to call another subroutine which determines why a particular instrument requested service (since there may be more than one possible cause). Finally, a subroutine(s) will be called to respond to the indicated event(s). Note that more than one instrument may request service simultaneously, and each instrument may have more than one event to report. These steps are summarized below.

1. Computer monitors HP-IB service request line (SRQ).
2. Receiver requests service by setting the SRQ line true.
3. Computer branches to routine that determines the instrument(s) that caused the SRQ.
4. Computer branches to routine that determines why a particular instrument is requesting service.
5. Computer branches to routine to process a specific event in a particular instrument.

Some of the routines above may be omitted, if only one instrument has been instructed to use the SRQ line, or if a particular instrument has been instructed to use the SRQ line for only one event.

Several system-level statements are required to make the computer responsive to service requests. The HP BASIC statement, `ENABLE INTR` (enable interrupt), tells the computer to monitor the service-request line. The on-interrupt statement, `ON INTR`, specifies where the computer program will branch when a service request occurs. If more than one instrument could cause the service request, or if an instrument can cause a service request for more than one reason, the serial-poll statement, `SPOLL`, is used. The serial-poll statement is always required to clear the service request being generated by the instrument.

### Receiver Status Byte

The status byte indicates the status or occurrence of certain receiver functions. The status byte contains eight bits, numbered 0—7 with bit 0 being the least significant bit.

## 4-8 Programming

Bits 0, 1, 2, 3, 4, 5, and 7 represent specific conditions or events. These bits are referred to as condition bits and event bits. Condition bits reflect a condition in the receiver which may be present or absent at any given moment. Event bits reflect the occurrence of a transition or event within the receiver.

Bit 6 is set by the receiver to indicate whether or not it is requesting service.

When the receiver is instructed not to use the service request line on HP-IB, the status bits always reflect the current condition of the receiver. In this situation, the *event bits* in the status byte should not be used. Event bits are only true at the exact instant of a transition in the receiver and as such are not reliable when service requests are disabled.

When the receiver is instructed to generate service requests for one or more conditions or events, the status bits reflect the current condition of the receiver until a service request is generated. Then, the bits which are generating the service request are held true until the status byte is read out of the receiver (by the HP BASIC SPOLL system-level statement), by the STB? command, or until an HP-IB DEVICE CLEAR (HP BASIC CLEAR system-level statement) is received. These actions clear the status byte to once again reflect the current conditions and events within the receiver.

### The Service-Request Mask

The service-request mode is enabled and controlled by the request-service-condition command, RQS. It defines a service-request mask that specifies which of the status-byte bits may generate a service request. Below, RQS specifies the ERROR-PRESENT and COMMAND-COMPLETE states (bits 5 and 4) for service requests.

```
OUTPUT @Rx;"RQS 48;"           Selects bit 5 and 4 (32+16) to enable service request mode for ERROR-PRESENT and COMMAND-COMPLETE.
```

```
OUTPUT @Rx;"RQS ";DVAL("00110000",2)   Also selects bits 5 and 4 as above, but is somewhat easier to read.
```

Once RQS is executed, the receiver requests service by setting the SRQ line true when the desired conditions or events occur.

### Receiver Status Byte

Bit Number	Decimal Equivalent	Receiver State	Description	Bit Type
7	128	OUT OF RANGE		
6	64	RQS	Set when service request is being generated.	—
5	32	ERROR-PRESENT	Set when error register contains an error.	condition
4	16	COMMAND-COMPLETE	Set at completion of command execution.	event
3	8	ZEROING		
2	4	Not Used		
1	2	MESSAGE	Set when messages are displayed.	condition
0	1	Not Used		

## **Monitoring System Operation without Using Service Requests**

The STB command may be used to monitor the value of the status byte at any time. Executing STB? returns the decimal equivalent of the status byte to the computer. Executing STB is similar to conducting a serial poll of the status byte. When STB is executed, the status-byte is updated to reflect current receiver conditions.



## Specifications and Characteristics

---

The specifications in this chapter are divided into two sections. These cover both the *search* and *collection* capabilities of the HP 71910A wide bandwidth receiver. Collection specifications and characteristics refer to the 321.4 MHz IF and video outputs of the HP 70911A IF module (IF bandwidths from 10 to 100 MHz). Search specifications refer to displayed and reported signals when the receiver is used as a spectrum analyzer (resolution bandwidths of 3 MHz and below).

All specifications apply after the following conditions are met:

- The instrument's temperature has been stabilized after one-hour continuous operation (0° to 55°C).
- Calibration routine has been run. Refer to Chapter 3.
- The microwave preselector peak function has been executed. Refer to the spectrum analyzer's documentation for information on the microwave preselector peak function.
- A 50Ω termination is present on the HP 70911A's rear panel 321.4 MHz OUT connector (321.4 MHz OPT OUT connector on option instruments).

Where specifications are subject to minimization with error correction routines, corrected limits are given unless noted.

### Contents

Definitions of Terms .....	5-2
HP 71910A Collection Receiver Specifications .....	5-3
HP 71910A Search Receiver Specifications .....	5-9
General Specifications .....	5-15
Physical Dimensions of Mainframes .....	5-16
Regulatory Information .....	5-17

---

**Note** For specifications of a particular "P" system, refer to the corresponding "A" system. There are no specification changes between the "P" and "A" systems, only module placement and rear-panel cabling are different.

---

---

## Definitions of Terms

The distinction between specifications, *characteristics*, typical performance, and nominal values is described as follows:

- *Specifications* describe warranted performance over the temperature range 0° to 55°C (unless otherwise noted).
- *Characteristics* provide useful, but nonwarranted information about the functions and performance of the instrument. *Characteristics are printed in italics.*
- *Typical Performance*, where listed, is nonwarranted, but indicates performance which most units will exhibit.
- *Nominal Value* is an expected, but nonwarranted, value of the parameter.

# HP 71910A Collection Receiver Specifications

## Frequency

<b>Frequency Range</b>	
Standard	100 Hz—26.5 GHz
With HP 11974 preselected mixers	100 Hz—75 GHz
With HP 11970 mixers	100 Hz—110 GHz
<b>Tuning Resolution</b>	1 Hz
<b>Frequency Reference Accuracy</b>	
	<b>w/HP 70310A (standard)      w/o HP 70310A (Option 110)</b>
Aging	< $1 \times 10^{-7}$ /year                      < $3 \times 10^{-6}$ /year
Aging (7-day average)	< $5 \times 10^{-10}$ /day
Temperature Drift	< $7 \times 10^{-10}$ < $1 \times 10^{-5}$
<b>IF Bandwidth (-3 dB, 5-pole synchronously tuned)</b>	
Range	10 MHz—100 MHz in 10% increments <sup>1</sup>
Accuracy (321.4 MHz IF Output)	±15%
Accuracy (Video Output)	±20%
Selectivity (-60 dB/-3 dB)	<12:1
Selectivity (-60 dB/-3 dB)	<8:1 with preselector ( <i>characteristic</i> )
<b>Video Bandwidth</b>	
Range	10 kHz—30 MHz and > 100 MHz (1, 3, 10 sequence)
Accuracy ( <i>characteristic</i> )	±30% (10 kHz to 30 MHz)

1 RF/IF bandwidth may be limited by HP 70910A preselector (>36 MHz) or low-band filter (>48 MHz).

## Gain

<b>RF/IF Gain</b>	+5 dB ( <i>characteristic</i> ) 1
<b>RF Attenuation</b>	0 to 65 dB in 5 dB steps
<b>RF Preamplifier Gain</b>	+28 dB ( <i>characteristic</i> ) (requires Option 016 or 017)
<b>IF Gain</b>	0 to 70 dB in 1 dB steps
<b>IF Step Gain Accuracy</b>	
0 to 55°C	±0.75 dB, 10 to 40 dB ±1.0 dB, 50 to 70 dB
20 to 30°C	±0.25 dB, 10 to 40 dB ±0.30 dB, 50 to 60 dB ±0.75 dB, 70 dB

1 At 321.4 MHz Out (assumes 0 dB RF ATTEN and 0 dB IF Gain). RF/IF Gain is -5 dB at 70 MHz IF Output (Option 001), -14 dB at 140 MHz IF Output (Option 002), and +5 dB for 70 MHz IF channel filter output (Option 007).

## Dynamic Range

<b>Third-Order Intercept</b>	<b>Standard</b>	<b>Option 016 or 017<sup>1</sup> (characteristic)</b>		
		<b>Preamp Bypass</b>	<b>Preamp On</b>	
	20 MHz—2.9 GHz	9 dBm	11 dBm	-16 dBm
	2.7 GHz—6.2 GHz	4 dBm	6 dBm	-21 dBm
6.0 GHz—26.5 GHz	2 dBm	4 dBm	-23 dBm	
<b>1 dB Gain Compression (characteristic)</b>	<b>Standard</b>	<b>Option 016 or 017<sup>1</sup></b>		
		<b>Preamp Bypass</b>	<b>Preamp On</b>	
	$\leq -5$ dBm	$\leq -5$ dBm	$\leq -33$ dBm	
<b>One-Tone Spurious-Free Dynamic Range<sup>2</sup> (characteristic)</b>	10 MHz—12.0 GHz	67 dB	70 dB	56 dB
	12.0 GHz—26.5 GHz	70 dB	70 dB	70 dB
<b>Image Rejection<sup>3</sup></b>	<b>Image Frequency</b>	<b>Center Frequency</b>	<b>Rejection</b>	
	642.8 MHz	100 kHz—2.9 GHz	-85 dBc	
	642.8 MHz	2.7—18.0 GHz	-70 dBc	
	642.8 MHz	18.0—26.5 GHz	-60 dBc	
<b>Internally Generated Spurs<sup>4</sup></b>	$-60$ dBm (characteristic)			
<b>Linear Detector Dynamic Range<sup>5</sup></b>	$30$ dB (characteristic)			

1 Use preamp bypass characteristics below 100 kHz for Option 016 and below 1 GHz for Option 017. Noise figure, TOI, and dynamic range with preamplifier on are measured with 5 dB RF attenuation. 1 dB gain compression with preamplifier on is measured with 10 dB attenuation.

2 Normalized to 1 MHz IF bandwidth. Values given for 0 dB step gain. Varies with step gain.

3 For RF input levels  $< 0$  dBm, input attenuation  $> 10$  dB.

4 300 MHz residual generated in low band of HP 70910A module. Appears 21.4 MHz away from IF center frequency. Applies only to center frequency  $< 2.9$  GHz and IF bandwidth  $> 30$  MHz.

5 Refers to dynamic range of video output of HP 70911A. Assumes IF Gain set properly.

## Noise

Noise Figure	Standard	Option 016 or 017 <sup>1</sup>	
		Preamp Bypass	Preamp On
1 MHz—12.8 GHz	32 dB	33 dB	13 dB
12.6 GHz—22.0 GHz	39 dB	41 dB	18 dB
22.0 GHz—26.5 GHz	43 dB	46 dB	21 dB
Phase Noise	Noise Sideband <sup>2</sup> (dBc/Hz)		
	N=1	N=2	N=4
10 kHz carrier offset	< -108	< -102	< -96
Phase Jitter, SSB, 100 Hz—25 MHz ( <i>characteristic</i> )			
10 MHz—6.2 GHz	0.2° RMS		
6.0 GHz—12.8 GHz	0.4° RMS		
12.6 GHz—26.5 GHz	0.8° RMS		

<sup>1</sup> Use preamp bypass characteristics below 100 kHz for Option 016 and below 1 GHz for Option 017. Noise figure, TOI, and dynamic range with preamplifier on are measured with 5 dB RF attenuation. 1 dB gain compression with preamplifier on is measured with 10 dB attenuation.

<sup>2</sup> N is the harmonic mixing number, N=1<sup>-</sup> from 100 kHz to 6.2 GHz, N=2<sup>-</sup> from 6.0 GHz to 12.8 GHz, and N=4<sup>+</sup> from 12.6 GHz to 26.5 GHz.

### HP 70900B LO Section Inputs and Outputs Characteristics

300 MHz Calibrator Output	
Connector	BNC (f), 50Ω (nominal)
Output Power	-10 dBm ±0.3 dB (specified)

## HP 70910A Wide Bandwidth RF Section Inputs and Outputs Characteristics

<b>RF Input<sup>1</sup></b>		
Connector	APC 3.5, 50Ω (nominal)	
VSWR (>10 dB attenuation)		
0—6.2 GHz	< 1.4:1	
6.0 GHz—26.5 GHz	< 2.0:1	
VSWR (<10 dB attenuation)	< 3.0:1	
LO emissions (>10 dB attenuation)	<b>Preselector On</b>	<b>Preselector Bypass</b>
0—2.9 GHz	< -100 dBm	< -80 dBm
2.7 GHz—26.5 GHz	< -100 dBm	< -50 dBm
RF Bandwidth <sup>2</sup>	<b>Preselector On</b>	<b>Preselector Bypass</b>
0—2.9 GHz	> 48 MHz	> 48 MHz
2.7 GHz—26.5 GHz	> 36 MHz	> 200 MHz
Maximum Safe Input Level (specification)		
dc	±0 Volts	
ac (attenuation = 0)	+15 dBm	
ac (attenuation ≥10 dB)	+30 dBm	
Pulse	100W, 10μs (attenuation ≥50 dB)	
<b>321.4 MHz External Mixer IF Input<sup>1</sup></b>		
Connector	SMA (f), 50Ω (nominal)	
Return Loss	≥ 14 dB from 271.4 to 371.4 MHz	
Maximum safe Input Level (spec.)	ac: 0 dBm, dc: ±3V	
Noise Figure	< 7.0 dB	
SHI	> (+30 - conversion loss) dBm	
TOI	> (+10 - conversion loss) dBm	
<b>Tune and Span Output<sup>1</sup></b>		
Connector	BNC (f), >10 kΩ load impedance	
Voltage Range	0 to +13.25V	
Tuning Sensitivity		
RF input chosen	0.5 V/GHz RF frequency	
External mixer	1.5 V/GHz LO frequency	
<b>First LO Output<sup>1</sup></b>		
Connector	SMB (f), 50Ω VSWR < 2.1:1	
Frequency Range	3.0 to 6.6 GHz	
Output Power (specification)	<b>25°C ±5°C</b>	<b>0°C—55°C</b>
Minimum	14.5 dBm	14.0 dBm
Maximum	17.0 dBm	17.5 dBm

1 Characteristics except where noted.

2 Measured at RF Section 321.4 MHz IF Output. For access, user must disconnect from HP 70911A 321.4 MHz IF Input.

## HP 70911A Ultra-Wide Bandwidth IF Section Inputs and Outputs Characteristics

<b>Video Output<sup>1</sup></b>		
Connector	BNC (f), 50Ω (nominal)	
Bandwidth (-3 dB)	<i>As selected by IF and video BW<sup>2</sup></i>	
Level	<i>0—1 Volts</i>	
VSWR	<i>&lt;1.5:1</i>	
Risetime	<i>&lt;10 ns</i>	
<b>321.4 MHz Out<sup>1,3</sup></b>		
Connector <sup>4</sup>	Rear panel SMB (m), 50Ω (nominal)	
Bandwidth (-3 dB)	IF Bandwidth, as selected <sup>2</sup>	
Group Delay Variation <sup>5</sup>	<i>5 ns, (preselector bypassed) 0 to 55° C</i> <i>3 ns, (preselector bypassed) 20 to 30° C</i>	
VSWR	<i>&lt;2.0:1</i>	
<b>321.4 MHz Option Output<sup>1,3</sup></b>		
Connector	Rear panel SMB (m), 50Ω (nominal)	
Bandwidth (-3 dB)	IF bandwidth, as selected <sup>2</sup>	
VSWR	<i>&lt;2.0:1</i>	
<b>I and Q Video Outputs (Option 004)<sup>1,3</sup></b>		
Connector	BNC (f), 50Ω (nominal)	
Level	<i>±0.5V</i>	
Bandwidth (-3 dB)	<i>50 MHz (each channel)</i>	
Quadrature Error	<i>6°</i>	
I/Q Gain Imbalance	<i>1.25 dB</i>	
Total Harmonic Distortion	<i>&lt;1% (&lt;-40 dBc)</i>	
Spurious Emissions	<i>&lt;-70 dBc (non-harmonic)</i>	
Rise Time (10—90%)	<i>≤10 ns</i>	
Residual dc Offset	<i>±25 mV</i>	
VSWR	<i>&lt;1.5:1</i>	
<b>FM Video Output (Option 005)<sup>1,3</sup></b>		
Connector	BNC (f), 50Ω (nominal)	
Level	<i>±0.5V</i>	
VSWR	<i>&lt;1.5:1</i>	
Pk-Pk Deviation	<b>FM Sensitivity</b>	<b>Linearity</b>
10 MHz	<i>0.1V/MHz</i>	<i>±0.5%</i>
40 MHz	<i>0.025V/MHz</i>	<i>±0.15%</i>
Modulation Frequency	12 MHz (maximum)	
Spurious Emissions	-35 dBm	

1 Characteristics except where noted.

2 Maximum IF bandwidth equals 100 MHz for center frequencies between 2.7 GHz and 26.5 GHz and preselector in bypass. Preselector limits bandwidth to >36 MHz. For center frequency less than 2.9 GHz, HP 70910A filter limits bandwidth to >48 MHz. (A special option is available for wider filter.)

3 IF and demod outputs are inverted for center frequency <12.8 GHz due to “minus” harmonic mixing.

4 For access, disconnect from 321.4 MHz OPT IN.

5 Maximum peak-to-peak variation over 80% of the selected IF bandwidth.

**HP 70911A Ultra-Wide Bandwidth IF Section Inputs and Outputs  
Characteristics (continued)**

<b>70 and 140 MHz IF Outputs<sup>1,2,3</sup></b>		
Connector	Rear panel SMB (m), 50Ω (nominal)	
VSWR	< 1.5:1 (70 MHz); < 2.0:1 (140 MHz)	
	<b>IF Frequency</b>	
Bandwidth (-3 dB)	<b>70 MHz</b>	<b>140 MHz</b>
Preselector On	36 MHz	36 MHz
Preselector Bypass	40 MHz	70 MHz
Group Delay Variation <sup>4</sup>		
Preselector On	25 ns	25 ns
Preselector Bypass	25 ns	25 ns
Amplitude Variation <sup>4</sup>	2.0 dB	4.5 dB
Symbol Error Rate <sup>5</sup>	1 x 10 <sup>-6</sup> for E <sub>b</sub> /N <sub>0</sub> > 25 dB	
Noise Power Ratio <sup>6</sup>	> 40 dB, asymptotic	
70 MHz IF Channel Filters <sup>7</sup>	Five switchable channel filters. 6-pole, 0.1 dB ripple Chebyshev. -3 dB IF bandwidths are 1.25, 5, 10, 20, and 36 MHz.	
Custom Channel Filters <sup>8</sup>	Up to five filters, installed and tested by HP.	

1 Characteristics except where noted.

2 IF and demod outputs are inverted for center frequency < 12.8 GHz due to "minus" harmonic mixing.

3 Requires Options 001 and 002, respectively.

4 Maximum peak-to-peak variation over 80% of the IF output bandwidth.

5 Measured with 64 QAM signal at 150 Mbits/s with 2 GHz < center frequency < 12 GHz.

6 For 2700 channel loading in a 36 MHz band with 2 GHz < center frequency < 12 GHz.

7 Requires Options 001 and 007.

8 Requires Options 001 or Option 002 and special option.



# HP 71910A Search Receiver Specifications

## Frequency

<b>Frequency Range</b>	See HP 71910A Collection Receiver Specifications in this chapter.		
<b>Frequency Readout Accuracy<sup>1</sup></b>			
Span $\leq 10$ MHz x N	$\pm[(\text{freq. readout})(\text{freq. ref. accuracy})+1.0\% \text{ of span} + 10 \text{ Hz}]$		
Span $> 10$ MHz x N			
Sweep $\geq 20$ ms	$\pm[(\text{freq. readout})(\text{freq. ref. accuracy})+1.5\% \text{ of span} + 10 \text{ Hz}]$		
10 ms $\leq$ sweep $< 20$ ms	$\pm[(\text{freq. readout})(\text{freq. ref. accuracy}) + 2.5\% \text{ of span} + 10 \text{ Hz}]$		
<b>Frequency Span<sup>1</sup></b>			
Range	0—26.5 GHz in 0.5% increments		
Accuracy			
Span $\leq 10$ MHz x N	$\pm[1\% \text{ of span} + (\text{span})(\text{freq. ref. accuracy})]$		
Span $> 10$ MHz x N			
sweep $\geq 50$ ms	$\pm[1.5\% \text{ of span}+(\text{span})(\text{freq. reference accuracy})]$		
50 ms $>$ sweep $\geq 20$ ms	$\pm[2.5\% \text{ of span}+(\text{span})(\text{freq. reference accuracy})]$		
20 ms $>$ sweep $\geq 10$ ms	$\pm[4.0\% \text{ of span}+(\text{span})(\text{freq. reference accuracy})]$		
<b>Tuning Resolution</b>	See HP 71910A Collection Receiver specifications in this chapter.		
<b>Frequency Reference Accuracy</b>	See HP 71910A Collection Receiver Specifications in this chapter.		
<b>Spectral Purity</b>	<b>Noise Sideband<sup>1</sup> (dBc/Hz) (<i>characteristic</i>)</b>		
Carrier Offset	<b>N=1</b>	<b>N=2</b>	<b>N=4</b>
100 Hz	-85	-79	-73
300 Hz	-88	-82	-76
1 kHz	-94	-88	-82
3 kHz	-104	-98	-92
10 kHz (specification)	$< -108$	$< -102$	$< -96$
30 kHz	-111	-105	-99
100 kHz	-115	-109	-103
300 kHz	-123	-117	-111
1 MHz	-135	-129	-123
3 MHz	-145	-139	-133
10 MHz	-153	-147	-141
Line and System Related Sidebands <sup>1</sup>	$< -65 \text{ dBc} + 20 \log N$		

<sup>1</sup> In the equations, N is the harmonic mixing number, N=1<sup>-</sup> from 100 kHz to 6.2 GHz, N=2<sup>-</sup> from 6.0 GHz to 12.8 GHz, and N=4<sup>+</sup> from 12.6 GHz to 26.5 GHz.

### Frequency (continued)

<b>Residual FM<sup>1</sup></b>	
Span > 10 MHz x N	<N x 25 kHz <sub>p-p</sub> in 0.1s (100 kHz measurement bandwidth)
Span < 10 MHz x N	Determined by phase noise. See Phase Noise section of HP 71910A Collection Receiver Specifications in this chapter.
<b>Frequency Drift<sup>1</sup></b>	
(Span >10 MHz x N)	±1 kHz/s, during sweep. Not cumulative from sweep to sweep. ±150 kHz/°C
<b>Sweep Time</b>	
Range	10 ms to 1000s (continuous)
Accuracy with HP 70700A	±2%
Swept frequency spans	15 ms to 355s
Fixed frequency (zero span)	80 μs to 355s with 800 point trace
<b>Trigger</b>	
	free run, line, video, and external
<b>IF Resolution Bandwidth</b>	
HP 70902A	10 Hz—300 kHz <sup>2</sup>
HP 70903A	100 kHz—3 MHz <sup>2</sup>
Accuracy	±20%
Selectivity (−60 dB/−3 dB)	
10 Hz—3 kHz	<12:1 (5-pole, synchronously tuned)
10 kHz—3 MHz	<16:1 (4-pole, synchronously tuned)
<b>Video Bandwidth</b>	
Range	
HP 70902A	3 Hz—300 kHz (1, 3, 10 sequence)
HP 70903A	300 Hz—3 MHz (1, 3, 10 sequence)
Accuracy <sup>3</sup>	±20% ( <i>characteristic</i> ).

<sup>1</sup> In the equations, N is the harmonic mixing number, N=1<sup>−</sup> from 100 kHz to 6.2 GHz, N=2<sup>−</sup> from 6.0 GHz to 12.8 GHz, and N=4<sup>+</sup> from 12.6 GHz to 26.5 GHz.

<sup>2</sup> Bandwidths are in 1, 3, 10 sequence and 10% increments except 3 kHz—10 kHz.

<sup>3</sup> When set to maximum (300 kHz or 3 MHz), bandwidth is >300 kHz (HP 70902A) or >4.5 MHz (HP 70903A).

## Amplitude

<b>Total Amplitude Range</b>	-138 to +30 dBm	
<b>Displayed Average Noise Level Standard<sup>1</sup></b>	<b>Frequency</b>	<b>DANL</b>
	100 Hz	< -92 dBm ( <i>characteristic</i> )
	300 Hz	< -95 dBm ( <i>characteristic</i> )
	1 kHz	< -101 dBm ( <i>characteristic</i> )
	3 kHz	< -111 dBm ( <i>characteristic</i> )
	10 kHz	< -118 dBm ( <i>characteristic</i> )
	30 kHz	< -118 dBm ( <i>characteristic</i> )
	100 kHz	< -122 dBm ( <i>characteristic</i> )
	300 kHz	< -130 dBm ( <i>characteristic</i> )
	1 MHz	< -139 dBm ( <i>characteristic</i> )
	3 MHz	< -139 dBm ( <i>characteristic</i> )
	10 MHz—2.0 GHz	< -138 dBm
	2.0—12.8 GHz	< -137 dBm
	12.6—22.0 GHz	< -130 dBm
	22.0—26.5 GHz	< -128 dBm
<b>With HP 70620B (Option 016/017)</b>	1.0—12.8 GHz	< -155 dBm
	12.6—22.0 GHz	< -150 dBm
	22.0—26.5 GHz	< -148 dBm
<b>Gain Compression Level<sup>2</sup></b>	≤ 0.5 dB for signal levels ≤ 0 dBm	
<b>Spurious Responses<sup>3</sup></b>	<b>Band</b>	<b>Response</b>
	100 Hz—10 MHz	< -60 dBc
<b>Second Harmonic Distortion (preselector on)</b>	10 MHz—26.5 GHz (preselector ON)	< -70 dBc
	<b>Band</b>	<b>Response</b>
	100 Hz—20 MHz	< -60 dBc
	20 MHz—2.9 GHz	< -75 dBc
	2.9—26.5 GHz	< -100 dBc

1 10 Hz Res BW, 0 dB attenuation, 3 Hz Video BW, Ref Level < -75 dBm.

2 10 dB input attenuation.

3 For < -30 dBm total signal power at the RF input with 10 dB attenuation. Exceptions noted.

### Amplitude (continued)

<b>Third-Order Intermodulation</b>	<b>Center Frequency</b>	<b>Intermodulation Products</b>	<b>Equivalent TOI</b>
HP 70902A <sup>1</sup>	100 Hz—20 MHz	< -64 dBc	+2 dBm
	20 MHz—2.9 GHz	< -78 dBc	+9 dBm
	2.7—6.2 GHz	< -68 dBc	+4 dBm
	6.0—26.5 GHz	< -64 dBc	+2 dBm
HP 70903A <sup>2</sup>	100 Hz—20 MHz	< -54 dBc	+2 dBm
	20 MHz—2.9 GHz	< -68 dBc	+9 dBm
	2.7—6.2 GHz	< -58 dBc	+4 dBm
	6.0—26.5 GHz	< -54 dBc	+2 dBm
<b>Image Responses<sup>3</sup></b>			
6 MHz	< -85 dBc		
42.8 MHz	< -85 dBc		
642.8 MHz	See Image Rejection section of HP 71910A Collection Receiver specifications in this chapter.		
<b>Residual Responses (0 dB attenuation, input terminated)</b>			
10 MHz—26.5 GHz	< -100 dBm		
<b>Multiple and Out-of-Band Responses<sup>4</sup></b>			
< -70 dBc			
<b>Display Range (10 divisions)</b>			
Scale (logarithmic)	0.01—20 dB/div in 0.5% increments		
Scale (linear)	10% of reference level per division		
Reference Level (logarithmic)	+30 to -140 dBm		
Reference Level (linear)	7.07V to 22 nV		
<b>Frequency Response (10 dB attenuation, preselector peaked)</b>			
	<b>0—55 °C</b>	<b>20—30 °C</b>	<b>0—55 °C</b>
	<b>Peak Variation</b>	<b>Referenced to Calibrator<sup>5</sup></b>	<b>Referenced to Calibrator<sup>5</sup></b>
100 Hz—2.9 GHz	±1.5 dB	±2.0 dB	±2.0 dB
2.7—6.2 GHz	±2.0 dB	±2.0 dB	±3.0 dB
6.0—12.8 GHz	±2.0 dB	±2.0 dB	±3.0 dB
12.6—22.0 GHz	±2.0 dB	±2.0 dB	±3.5 dB
22.0—26.5 GHz	±2.5 dB	±2.5 dB	±4.0 dB
2.7—22 GHz <sup>6</sup>		<i>+2.0, -3.0 dB (characteristic)</i>	
22.0—26.5 GHz <sup>6</sup>		<i>+2.5, -3.5 dB (characteristic)</i>	

1 For two signals each  $\leq -20$  dBm total signal power at RF input, 10 dB attenuation, 20—30 °C.

2 For two signals each  $\leq -15$  dBm at the RF input, 10 dB attenuation, 20—30 °C.

3 RF input  $\leq 0$  dBm, attenuation  $\geq 10$  dB.

4 For inputs  $\leq 26.5$  GHz and RF levels  $\leq 0$  dBm,  $\geq 10$  dB attenuation, preselector on.

5 Referenced to 300 MHz, -10 dBm calibrator. Does not include  $\pm 0.3$  dB calibrator amplitude error.

6 Preset preselector DAC, 20—30 °C, referenced to calibrator for spans  $\leq 100$  MHz.

### Amplitude (continued)

<b>Input Attenuator</b>			
Range	0 to 65 dB in 5 dB steps.		
Switching Repeatability	±0.2 dB		
Accuracy <sup>1</sup> ( <i>characteristic</i> )			
0—2.9 GHz	±1.2 dB		
2.9—12.7 GHz	±2.3 dB		
12.7—19.9 GHz	±2.8 dB		
19.9—26.5 GHz	±4.8 dB		
Preselector Bypass Switch Repeatability	<±0.2 dB		
<b>IF Gain Accuracy</b>			
	<b>Gain</b>	<b>20—30°C</b>	<b>0—55°C</b>
HP 70902A	10 dB	±0.2 dB	±0.2 dB
	20 dB	±0.2 dB	±0.2 dB
	30 dB	±0.2 dB	±0.3 dB
	40 dB	±0.2 dB	±0.5 dB
	50 dB	±0.2 dB	±0.6 dB
	60 dB	±0.4 dB	±0.8 dB
HP 70903A	10 dB		±0.1 dB
	20 dB		±0.3 dB
<b>Scale Fidelity</b>			
Log (corrected)	<b>Bandwidth</b>	<b>Fidelity</b>	
HP 70902A (0 to 90 dB)	<30 Hz	±0.7 dB	
	30 Hz to 100 kHz	±0.5 dB	
	>100 kHz	±0.7 dB	
HP 70903A (0 to 75 dB)	≤1 MHz	±0.5 dB	
	≥1 MHz	±0.7 dB	
Log (uncorrected)	all	±3.0 dB	
Incremental Fidelity	0.1 dB/dB, all bandwidths		
Linear	±7.5% of reference level		
<b>Amplitude Temperature Drift</b> ( <i>characteristic</i> ) <sup>2</sup>			
HP 70902A	±0.05 dB/°C at 300 MHz, 100 Hz Resolution BW <sup>3</sup>		
HP 70903A	±0.05 dB/°C at 300 MHz, 300 kHz resolution BW <sup>3</sup>		
<b>Resolution Bandwidth Switching Repeatability</b>			
±0.2 dB in 1, 3, 10 sequence			
±3 dB (uncorrected)			
<b>Marker Resolution</b>	±0.03 dB		

1 Referenced to 10 dB setting.

2 -10 dBm reference level, 10 dB input attenuation

3 Accumulated error is eliminated by running internal correction routine.

## Inputs and Outputs

<b>HP 70900B LO Section</b>	See HP 71910A Collection Receiver Specifications in this chapter.
<b>HP 70910A Wide Band RF section</b>	See HP 71910A Collection Receiver Specifications in this chapter.
<b>HP 70911A Ultra-Wideband IF section</b>	See HP 71910A Collection Receiver Specifications in this chapter.
<b>HP 70902A IF section</b> Auxiliary Video Output 3 MHz IF Output (linear) Output Level	BNC (f), 0–1V, 1k $\Omega$ (nominal) BNC (f), 50 $\Omega$ < 1.5:1 VSWR ( <i>characteristic</i> ) –15 dBm (nominal) with –10 dBm at RF input, 0 dB attenuation, –10 dBm reference level.
<b>HP 70903A IF section</b> Auxiliary Video Output 21.4 MHz IF Output Output Level	BNC (f), 0–1V, 100 $\Omega$ (nominal) BNC (f), 50 $\Omega$ < 1.5:1 VSWR ( <i>characteristic</i> ) –15 dBm (nominal) with –10 dBm at RF input, 0 dB attenuation, –10 dBm reference level.
<b>HP-IB Codes</b>	SH1 AH1 T6 L4 SR1 RL1 DC1 PP0 DT1 E2 C1

## General Specifications

<b>HP 71910A System Components</b>	
HP 70001A mainframe	
HP 70004A display/mainframe	
HP 70900B Option 512 local oscillator (2 slots)	
HP 70310A precision frequency reference (1 slot)	
HP 70902A IF section (1 slot)	
HP 70903A IF section (1 slot)	
HP 70910A wide bandwidth RF section (2 slots)	
HP 70911A ultra-wide bandwidth IF section (2 slots)	
<b>Environmental Temperature</b>	
Operational	0 to 55°C
Storage	-40 to +75°C
<b>Humidity</b>	
Operational	0 to 95% relative humidity at 45°C
<b>EMC:</b> Conducted and radiated interference is in compliance with CISPR pub 11, FTZ 526/1979, and MIL-STD 461B, RE02/part 7.	
<b>Power Requirements (characteristic)</b>	
HP 71910A	404W
HP 70900B	57.2W
HP 70902A	22W
HP 70903A	18.7W
HP 70910A	39.6W
HP 70911A	36W standard; 50W full card cage
HP 70310A	20.9W
HP 70001A	42W <sup>1</sup>
HP 70004A	137W <sup>1</sup>
<b>Weight (nominal)</b>	
HP 71910A standard	55.6 kg (122.3 lbs.)
<b>Dimensions</b>	
HP 70001A mainframe	
height	177 mm (7 in.)
width	426 mm (16.75 in.)
length	526 mm (20.7 in.)
HP 70004A display/mainframe	
height	222 mm (8.7 in.)
width	426 mm (16.75 in.)
length	526 mm (20.7 in.)
<b>Calibration Cycle</b>	
	3 years recommended

<sup>1</sup> Accounts for power supply efficiency in standard configuration.

## Physical Dimensions of Mainframes

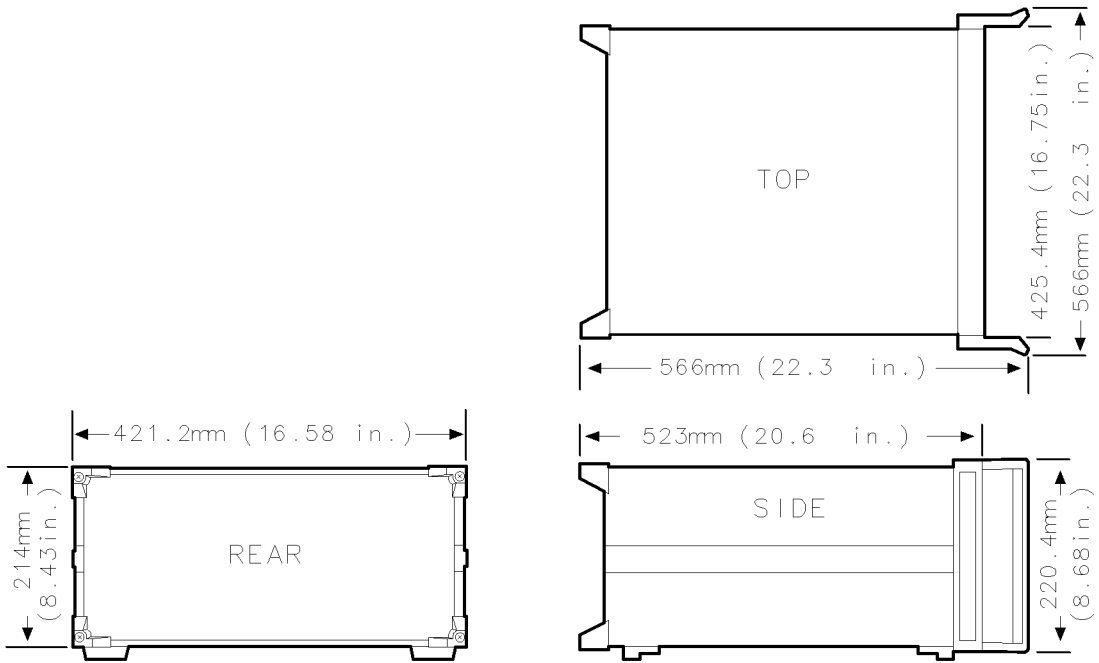

**HP 70004A Display/Mainframe Physical Dimensions**

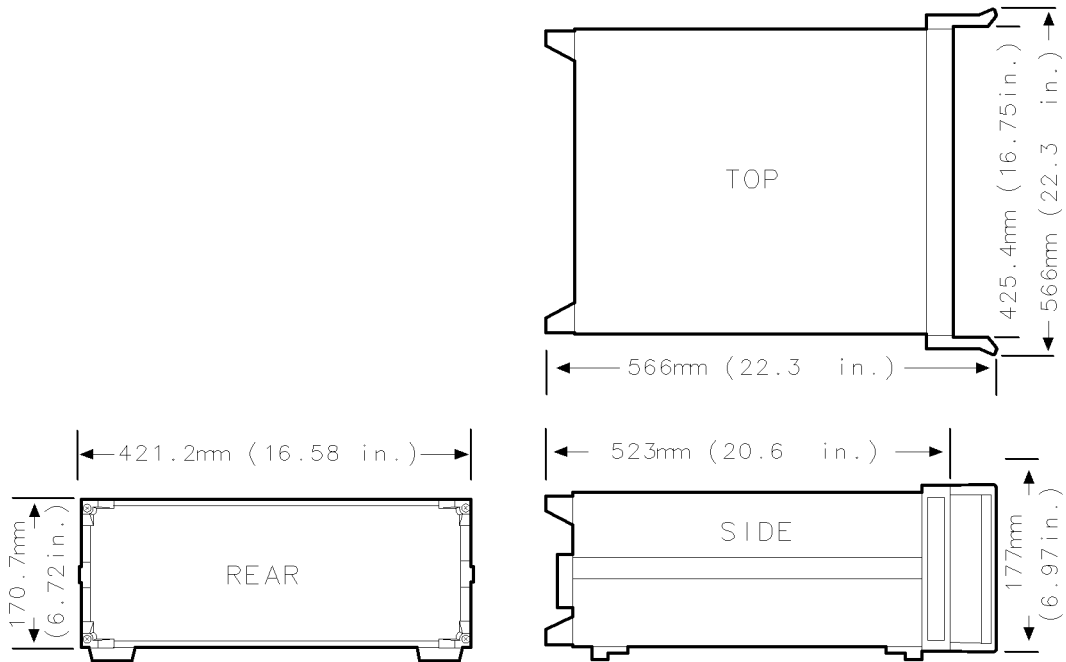

**HP 70001A Mainframe Physical Dimensions**



## Regulatory Information

<b>DECLARATION OF CONFORMITY</b> according to ISO/IEC Guide 22 and EN 45014		
<b>Manufacturer's Name:</b>	Hewlett-Packard Co.	
<b>Manufacturer's Address:</b>	1400 Fountaingrove Parkway Santa Rosa, California 95403 U.S.A.	
<b>Declares that the product:</b>		
Product Name:	Wide-Bandwidth Surveillance Receiver	
Model Numbers:	HP 71910A and HP 70911A	
Product Options:	This declaration covers all options of the above products.	
<b>Conforms to the following product specifications:</b>		
Safety:	IEC 348:1978/HD 401:1980	
EMC:	CISPR 11:1990 /EN 55011:1991, Group 1 Class A IEC 801-2:1991 /EN 50082-1:1992, 4 kV CD, 8 kV AD IEC 801-3:1984 /EN 50082-1:1992, 3V/m, 27-500 MHz IEC 801-4:1988 /EN 50082-1:1992, 500 V signal, 1000 V AC	
<b>Supplementary Information:</b>		
The products herewith comply with the requirements of the Low Voltage Directive 73/23/EEC and the EMC Directive 89/336/EEC.		
Santa Rosa, California	<i>Feb. 7, 1994</i>	
<u>Location</u>	<u>Date</u>	<u>Dixon Browder / Quality Manager</u>
<b>European Contact:</b> Your local Hewlett-Packard Sales and Service Office or Hewlett-Packard GmbH, Department ZQ/Standards Europe, Herrenberger Straße 130, D-7030 Böblingen (FAX: + 49-7031-143143)		

## **Notice for Germany: Noise Declaration**

LpA < 70 dB

am Arbeitsplatz (operator position)

normaler Betrieb (normal position)

nach DIN 45635 T. 19 (per ISO 7779)

## Menu Maps

---

This chapter contains a menu map for the receiver personality. The menu map graphically represents all top-level menus and their associated lower-level softkeys. To view these softkeys on the HP 71910A, press **USER** and then **RX\_MODE**. Refer to the *HP 70000 Modular Spectrum Analyzer Operating Manual* for menu maps of the spectrum analyzer softkeys; these softkeys are displayed when the receiver is first turned on and when **MENU** is pressed.

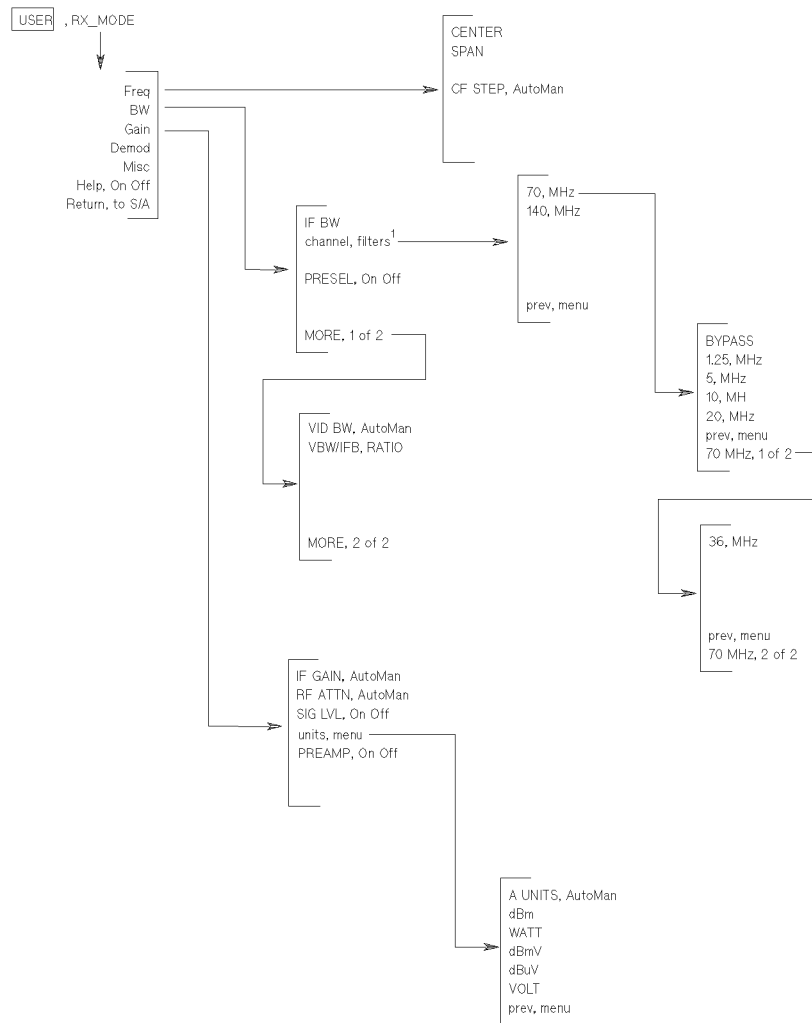

<sup>1</sup> These menus are displayed only on Option 007 instruments.

## Receiver Personality Softkeys (1 of 2)

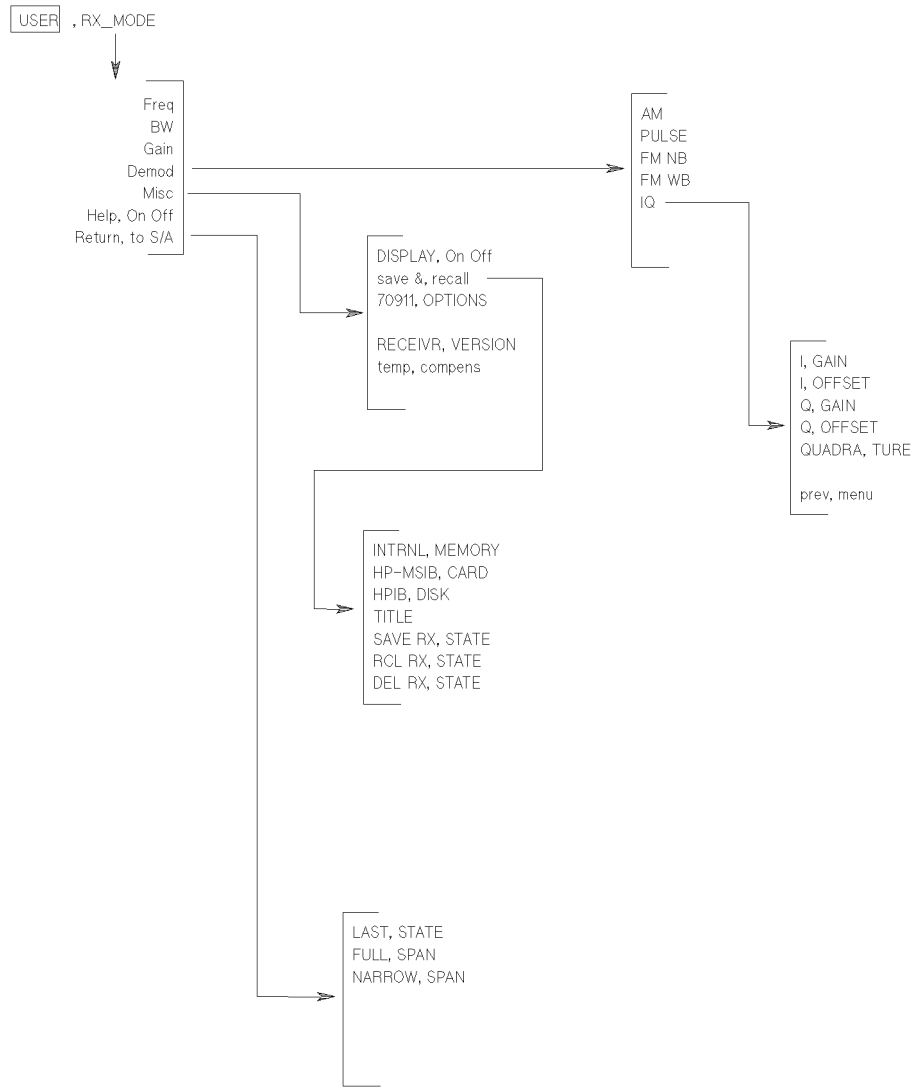

**Receiver Personality Softkeys (2 of 2)**



## Dictionary Reference

---

This chapter contains a description of the following items:

- Receiver personality softkeys.
- Front-panel keys
- HP 70911A module front and rear panel connectors.

Refer to the *HP 70000 Modular Spectrum Analyzer Operating Manual* for information on the following items:

- Softkeys accessed by pressing **MENU**.
- Front and rear panel connectors not listed in this chapter.

For information on softkeys available through the **DISPLAY** key, refer to the *HP 70004A Color Display User's Guide* (when using the HP 71910A) or the *HP 70207A User's Guide* (when using the HP 71910P).

---

## Alphabetical Listing

### 1.25 MHz

Selects the Option 007 1.25 MHz Chebyshev channel filter. This filter is used with the Option 001 70 MHz IF path. This softkey is displayed only on Option 007 instruments.

### 5 MHz

Selects the Option 007 5 MHz Chebyshev channel filter. This filter is used with the Option 001 70 MHz IF path. This softkey is displayed only on Option 007 instruments.

### 10 MHz

Selects the Option 007 10 MHz Chebyshev channel filter. This filter is used with the Option 001 70 MHz IF path. This softkey is displayed only on Option 007 instruments.

### 20 MHz

Selects the Option 007 20 MHz Chebyshev channel filter. This filter is used with the Option 001 70 MHz IF path. This softkey is displayed only on Option 007 instruments.

### 36 MHz

Selects the Option 007 36 MHz Chebyshev channel filter. This filter is used with the Option 001 70 MHz IF path. This softkey is displayed only on Option 007 instruments.

### 70 MHz

Selects the 70 MHz IF channel filter path. Because the 70 MHz IF channel filters are only available in Option 007 instruments, this softkey only appears if the Option 007 is installed. Pressing this softkey displays a menu that is used for selecting the channel filters.

## 70 MHz OUT

Rear-panel connector on the HP 70911A Option 001 modules. This IF output is available for characterization by an external device such as an oscilloscope or demodulator. If Option 007 is installed, channel filters are available for switching into the 70 MHz path. Refer to Chapter 3 for information on how to select and use channel filters.

## 140 MHz OUT

Rear-panel connector on HP 70911A Option 002 modules. This IF output is available for characterization by an external device such as an oscilloscope or demodulator.



### **300 MHz IN**

Rear-panel connector on the HP 70911A Option 001 or Option 002 modules. Connect this input to a 300 MHz OUT connector on the HP 70900B local oscillator module.

### **300 MHz OUT**

Rear-panel connector on the HP 70911A Option 001 or Option 002 modules. This signal originates on the HP 70900B local oscillator module.

### **321.4 MHz IN**

Rear-panel connector on the HP 70911A module. This connection receives the 321.4 MHz IF output of the HP 70910A wide bandwidth RF module.

### **321.4 MHz OPT IN**

Rear-panel connector on the HP 70911A Option 001 or Option 002 modules. This input is connected to the rear-panel 321.4 MHz OUT connector.

### **321.4 MHz OPT OUT**

Rear-panel connector on the HP 70911A Option 001 or Option 002 modules. This output is the IF signal input to the 321.4 MHz OPT IN connector. It can be input into an external device such as an oscilloscope for characterization. This 321.4 MHz IF output has degraded IF bandwidth uncertainty when compared to the 321.4 MHz OUT connector on standard instruments.



### **321.4 MHz OUT**

Rear-panel connector on the HP 70911A module. With standard instruments, this IF output can be input into an external device such as an oscilloscope for characterization. On Option 001 and Option 002 instruments, this output connects to the 321.4 MHz OPT IN connector.

### **70911 OPTIONS**

Lists, on the display, all options that are installed in the HP 70911A wide-bandwidth IF module.



Use the  (backspace) key to backspace the cursor while entering text and to display previous softkey menus (in the  menus).



The step keys increase or decrease active parameter values. For example, if frequency span is the active parameter, pressing increases the span; pressing decreases the span.



Displays delta markers, which display the frequency and amplitude differences between two signals.

#### A UNITS AutoMan

Selects the displayed amplitude units. In the default condition, Auto is underlined and the receiver personality automatically selects the appropriate units. When Man underlined, you can choose from dB, volts, and watts .

#### AM

Selects demodulation of amplitude modulated signals. This is the default demodulation selected when the receiver mode is started. The ratio between the IF and video bandwidths is set to 0.3. The video bandwidth is only applied to the displayed signal and does not affect the downconverted signal that is available at the rear-panel outputs.

#### BYPASS

Selects the Option 007 bypass path which switches the Chebyshev channel filters out of the IF signal path. This softkey is displayed only on Option 007 instruments.

#### BW

Displays a menu for changing the IF and video bandwidths, enabling a custom filter, or updating the video to-IF-bandwidth ratio.

#### CENTER

Specifies the frequency displayed at the center of the screen when the instrument is in search mode. In collection mode (zero span) use this key to specify the fix-tuned frequency. When activated, the frequency at center screen can be changed using the front-panel knob, step keys, or numeric keypad. When the receiver mode is first entered, the center frequency is automatically set to the marker position. If no marker is present, the receiver sets the center frequency to the value of the signal having the highest peak.

## CENTER

Refer to **CENTER**.

## CF STEP AutoMan

Changes the center-frequency step size. This is the change in center frequency that occurs when the **▲** and **▼** step keys are pressed. The default step size is 10 percent of the frequency span. This is the applied value whenever the **CF STEP AutoMan** softkey is set to automatic. To change the step size, press **CF STEP AutoMan** and enter a value. Available step sizes vary with the span setting.

## channel filters

Allows you to select channel filters on Option 007 instruments. After pressing this softkey, a menu is displayed for choosing IF filtering bandwidths of 1.25, 5, 10, 20, and 36 MHz. You can also select a bypass path which has a 40 MHz bandwidth.

## dBm

Displays the average value of the signal in decibels relative to 1 milliwatt.

## dBmV

Displays the average value of the signal in decibels relative to 1 millivolt.

## dBuV

Displays the average value of the signal in decibels relative to 1 microvolt.

## DEL RX STATE

Deletes a receiver state file that has been previously saved using the **SAVE RX STATE** softkey.

## Demod

Displays a menu for selecting the type of demodulation used. Choices are: AM, pulse, FM narrowband or wideband (Option 005), or I/Q (Option 004). The default is AM demodulation.

With Option 005, the FM wideband and narrowband discriminator offset DACS can be adjusted. With Option 004, the gain and offset of both I and Q outputs can be adjusted. The quadrature is also adjustable.

## DISPLAY On Off

Use this softkey to turn off the display of traces and the graticule. This softkey does not affect the display when the instrument is returned to “search” mode.

## FM

Front-panel output connector on the HP 70911A Option 005 modules. This FM discriminator connector provides either a narrowband (10 MHz frequency deviation) or wideband (40 MHz frequency deviation) output. Use the receiver personality’s **FM NB** and **FM WB** softkeys to make the selection. Modulation frequencies up to half the bandwidth can be demodulated. For example, with a deviation of 10 MHz, a modulation frequency of 5 MHz can be processed. The maximum modulation frequency is 12 MHz.

### FM NB

Selects the FM narrowband discriminator. The FM discriminator has the following values: (Refer to Chapter 5, “Specifications and Characteristics” for more information.)

Sensitivity .....	0.1V/MHz
Maximum input deviation .....	±5 MHz
Maximum output .....	±0.5V

### FM WB

Selects the FM wideband discriminator. The FM discriminator has the following values: (Refer to Chapter 5, “Specifications and Characteristics” for more information.)

Sensitivity .....	0.025V/MHz
Maximum input deviation .....	±20 MHz
Maximum output .....	±0.5V

### Freq

Displays a menu for changing the measurement frequency and the span. Upon entering receiver mode, the frequency is automatically set to the value of any active marker. If there is no active marker, the frequency is set to the highest peak. As a default, the receiver is fixed-tuned with a span of zero hertz.

### FULL SPAN

Press this softkey to exit the receiver personality. The spectrum analyzer is restored to the following settings:

Tuning: .....	swept
Frequency Span: .....	full span
Resolution Bandwidth: .....	3 MHz

## Gain

Displays a menu for controlling IF gain, RF input attenuation, and signal averaging. In addition, you can select the amplitude units displayed for signal averaging.

## Help On Off

Turns online help on and off. When on, pressing any softkey displays a definition of the softkey's function. The function is not invoked.

## HOLD

Deactivates an active function to prevent accidental setting changes. In addition to protecting against accidental changes, **HOLD** removes the active function readout from the display and turns off the inverse video of an active softkey. For example, if the receiver personality's **CENTER** softkey has just been set to 1 GHz, **CENTER** remains the active function. So if the knob is turned or the step keys are accidentally pressed, the center frequency changes to a new value. Pressing **HOLD** protects the center frequency from knob or step key changes.

## HP-MSIB CARD

Accesses various types of external memory that are available through an HP-MSIB device. The **HP-MSIB CARD** softkey is used to select an HP-MSIB address. The type of external memory that is accessed must first be selected using the mass storage functions of the HP-MSIB device. For example, the **HP-MSIB CARD** softkey can be used to access articles in a memory card on an HP 70004A color display. Be sure that access to the memory card is selected, using the mass storage softkeys for the HP 70004A color display.

The **HP-MSIB CARD** softkey can access a disk drive through an HP-IB port that is connected to another HP-MSIB device or display. Be sure that access to the HP-IB port is selected using the mass storage softkeys for the HP-MSIB device. The **HP-MSIB CARD** softkey selects the HP-MSIB address of an HP-MSIB device. The default device address is the HP-MSIB address of the display (for example, an HP 70004A color display) that is connected to the analyzer. The number that **HP-MSIB CARD** specifies is the column address.

To look up the HP-MSIB address of a device or display, press **DISPLAY**, **address map**. Use the front-panel knob to locate the desired device address.

## HP-IB DISK

Selects external memory that is accessed on an HP-IB device (for example, a disk drive) that is connected to the receiver's HP-IB port.

The receiver's HP-IB port is located on the display (HP 70004A color display) or mainframe (70001A) that contains the local-oscillator module (70900B). HP-IB protocol does not allow more than one controller on HP-IB. When using the receiver as a controller, disconnect any external controller from the HP-IB.

When storing data on a disk drive, use **HP-IB DISK** to specify the HP-IB address, unit, and volume number of the disk drive. The default selection is HP-IB address 0, unit 0, volume 0.

To enter new values, press **HPIB DISK**, and enter numbers in the following sequence. The first number is for the HP-IB address. The second number is for unit. The third number is for volume. The second and third numbers are preceded by a period. For example,

**HPIB DISK** 1 **ENTER** selects HP-IB address 1, unit 0, volume 0.

**HPIB DISK** 0.1 **ENTER** selects address 0, unit 1, volume 0.

**HPIB DISK** 1.01 **ENTER** selects address 1, unit 0, volume 1.

#### Ranges of Entered Values

Parameter	Value Range
HP-IB address	0 – 30
unit number	0 – 9
volume number	0 – 9

## I

Front-panel output connector on the HP 70911A Option 004 modules. The I and Q connectors provide an analog IQ output for applications requiring constellation displays. Connect a two-channel oscilloscope in X-Y mode to these connectors. Use the **I GAIN** and **I OFFSET** softkeys to adjust the gain and dc offset of this channel. Use the **QUADRATURE** softkey to adjust the phase between the I and Q outputs to 90°.

### **I GAIN**

Sets the gain of the analog I channel. Because this output is only available on Option 004 instruments, this softkey only appears if this option is installed. The analog IQ outputs are useful for applications that require constellation displays. The adjustment values are unitless numbers that range from 0 to 4095.

### **I OFFSET**

Adjusts the dc offset of the analog I channel to zero volts. Because this output is only available on Option 004 instruments, this softkey only appears if this option is installed. The analog IQ outputs are useful for applications that require constellation displays. The adjustment values are unitless numbers that range from 0 to 4095.

### **IF BW**

Specifies the width of the IF bandwidth. The default IF bandwidth is 10 MHz. If you use the **SPAN** softkey to change the receiver from zero span, the IF bandwidth changes to a value that is optimized for the current span.

## IF GAIN AutoMan

Sets the amount of IF gain applied to the signal. When Auto is underlined, the receiver automatically selects the proper value. When Man is underlined, you can manually change the IF gain.

## INSTR

Assigns the HP 70004A display's front-panel keys to selected master modules. HP 70004A displays can display up to 4 windows with each window showing the display of a master module. (HP 70900B is an example of master module.) For example, suppose you had an MMS mainframe with an HP 70703A oscilloscope master module installed. After connecting the MMS mainframe to the HP 70004A display, you could display the screen of both analyzers on the HP 70004A display in separate windows. The **INSTR** key allows you to move front-panel key control between each master module in the system. Refer to the display's operation manual for information on building and displaying windows.

When the **INSTR** key is pressed, the display draws colored borders around the currently defined windows. Window location, pen number, and the normal colors assigned to those windows are defined in the following table.

**INSTR Key Window Assignments**

Window	Location	Pen Number	Normal Color
1	Lower Left	2	Yellow
2	Upper Left	3	Cyan
3	Upper Right	4	Pink
4	Lower Right	5	Green

Next to each displayed window is a softkey containing the first seven characters in the instrument's model number on the first line, and the module's HP-MSIB address (row, column) on the second. This softkey is displayed in reverse video in the same color as the associated window border. Press the softkey, and the keyboard is offered to that window's master module. If the module accepts the keyboard, it displays its menu keys as if the **MENU** key had been pressed.

## INSTR PRESET

Resets the instrument to a known preset state.

Pressing **INSTR PRESET** aborts any current operations, resets the instrument to a known preset state, and clears the HP-IB output queue. This function will not modify the HP-IB or HP-MSIB interfaces, the display's address map, or calibration data.

### INTRNL MEMORY

Sets the location for saving or recalling files to internal memory. Internal memory is located in the HP 70900B.

### IQ

Selects the optional IQ outputs. The analog IQ outputs are useful for applications that require constellation displays. For example, connect these outputs to a two-channel oscilloscope in X-Y mode to identify modulation formats such as QPSK, 8 PSK, 16 QAM, and 64 QAM. Both I and Q output signals have a bandwidth of 50 MHz (combined bandwidth of 100 MHz).

If Option 004 is installed, pressing this softkey presents a menu for adjusting the gain and dc offset of each output.

### LAST STATE

Press this softkey to exit the receiver personality. The spectrum analyzer is restored to the settings used before the receiver personality was invoked.

### MENU

Displays the softkeys for the search receiver mode (HP 71209A spectrum analyzer). If the DISPLAY front-panel key is pressed, softkey menus dedicated to controlling display functions are displayed. Press the MENU key to return to spectrum analyzer menus.

### Misc

Displays a menu of miscellaneous receiver functions. These include turning the graticule display off or on, saving or recalling receiver states, and displaying any installed HP 70911A options.

### NARROW SPAN

Press this softkey to exit the receiver personality. The spectrum analyzer is restored to the following settings:

Tuning: .....swept at current center frequency  
Frequency Span: ..... 10 times the IF bandwidth

### NB VID IN

Rear-panel connector on the HP 70911A module. This input video signal comes from the HP 70903A IF module's rear-panel VIDEO OUT connector.



**NEXT PEAK**

Moves a displayed marker to the next-highest signal peak.

**NORMAL**

Activates a frequency marker at the center of the screen on the active trace. The data controls are used to position the marker. An annotation in the active function area and in the upper-right corner indicate the frequency and amplitude of the marker.

**PEAK SEARCH**

Places an active marker on the highest amplitude trace point.

**PLOT**

Plots the display on a Hewlett-Packard plotter.

When pressed, **PLOT** sends vector plot data (HPGL graphics format) over HP-IB to the plotter specified in the HP 70004A's **DISPLAY** menu. Press the **DISPLAY** front-panel key and then the **Hard Copy** and **plotter address** softkeys to change the default plotter address. Press the **MENU** front-panel key to return to the spectrum analyzer menus.

The plotter's default HP-IB address is set to address 5. The default plotter limits are those of the HP 7470A and HP 7475A plotters. These allow 0.5 inch margins on standard A-size paper (8.5 by 11 inches).

**PREAMP On Off**

Turns an HP 70620B preamplifier on or off. The preamplifier is installed as an option to the HP 71910A receiver. It provides approximately 30 dB of signal amplification before the HP 70910A RF section. This softkey only appears if the HP 70620B's **RF INPUT** is selected.

**PRESEL On Off**

If you're downconverting signals between 2.7 and 26.5 GHz, you must turn off the microwave preselector to obtain the widest possible IF bandwidth. For example, if you select a 100 MHz IF bandwidth, but the microwave preselector is on, the effective bandwidth will be limited to approximately 40 MHz. This is shown in the following table. One advantage of leaving the preselector on is a slight improvement in sensitivity. More importantly, the preselector prevents multiple responses.

## Available Bandwidth of HP 70911A 321.4 MHz IF Output

Frequency Mode	Approximate Bandwidth
100 Hz—2.9 GHz	>48 MHz <sup>1</sup>
2.7—26.5 GHz	
preselected on	>36 MHz <sup>2</sup>
preselector off	100 MHz

1 This bandwidth is due to a filter in the RF path and not to the Microwave preselector.

2 The preselector's bandwidth increases at higher frequencies and is nearly 60 MHz at a 20 GHz center frequency.

### PRINT

Prints the display on a Hewlett-Packard graphics printer. When pressed, **PRINT** sends raster print data over HP-IB to the printer specified in the **DISPLAY** menu. Select printer types by pressing the **DISPLAY** front-panel key and then the **Hard Copy** and **printer config** softkeys. Press the **DISPLAY** front-panel key and then the **Hard Copy** and **printer address** softkeys to change the default printer address. The printer's default HP-IB address is set to address 1. Press the **MENU** front-panel key to return to the spectrum analyzer menus.

The print data is formatted in the HP-PCL (printer command language) graphics format.

### PULSE

Selects demodulation of pulse-modulated signals. The video bandwidth is set to a value that is greater than 100 MHz. Because the video bandwidth is only applied to the displayed signal, its value does not affect the downconverted signal that is available at the rear-panel IF outputs. It does affect the signal available at the front-panel VIDEO output.

### Q

Front-panel output connector on the HP 70911A Option 004 modules. The I and Q connectors provide an analog IQ output for applications requiring constellation displays. Connect a two-channel oscilloscope in X-Y mode to these connectors. Use the **Q GAIN** and **Q OFFSET** softkeys to adjust the gain and dc offset of this channel. Use the **QUADRATURE** softkey to adjust the phase between the I and Q outputs to 90°.

### Q GAIN

Sets the gain of the analog Q channel. Because this output is only available on Option 004 instruments, this softkey only appears if this option is installed. The analog IQ outputs are useful for applications that require constellation displays. The adjustment values are unitless numbers that range from 0 to 4095.

## Q OFFSET

Adjusts the dc offset of the analog Q channel to zero volts. Because this output is only available on Option 004 instruments, this softkey only appears if this option is installed. The analog IQ outputs are useful for applications that require constellation displays. The adjustment values are unitless numbers that range from 0 to 4095.

## QUADRATURE

Adjusts the phase difference between the Option 004 analog I/Q outputs to 90°. Use this adjustment to optimize the shape of constellations that are displayed on an oscilloscope. For example, if the displayed constellation is elliptical in shape instead of circular, adjust the quadrature setting. The adjustment values are unitless numbers that range from 0 to 4095.

## RCL RX STATE

Reconfigures the receiver into a state that has been saved in a receiver-state file. Files are recalled from the currently selected user memory. To select user-memory, select one of the following softkeys: **HP-MSIB CARD**, **HPIB DISK**, or **INTRNL MEMORY**.

To recall a file, press **RCL RX STATE**, enter the file number using the numeric keypad, then press **ENTER**.

## RECALL

Accesses a menu for recalling files from memory. You can recall instrument states, traces, limit lines, and user-menu files. To load a file, press the key for the desired file type, and then enter the file number. If you do not remember the file's number, press **recall from** to view a catalog of user-memory. **recall from** opens the **Misc** menu's catalog softkeys. You can also select user memory from this menu. Each file in the catalog has an identifying prefix, which distinguishes one type of file (and its contents) from the other file types.

**File Prefixes**

Prefix	File Type
d_	down-loadable program
l_	limit-line
s_	instrument state
t_	trace
u_	user menu

A number is listed to the left of each FILE name in the catalog. Use this entry number to recall the file. Press **LOAD FILE**, followed by the entry number, then press **ENTER**.

## RECEIVR VERSION

Displays the version of the receiver program.

## REF LEVEL

Sets the reference level which is the absolute amplitude power or voltage represented by the screen's top graticule. Enter the desired reference level value using the front-panel knob, step keys, or numeric keypad.

## Return to S/A

Displays a menu for exiting the receiver personality and returning to the spectrum analyzer mode. You can recall the state the analyzer was in upon entering the receiver mode, issue an instrument preset, or set the span to 10 times the IF bandwidth.

## RF ATTN AutoMan

Varies RF input attenuation from 0 to 65 dB in 5 dB increments.

Input attenuation is normally coupled to the reference level. When coupled, the attenuator changes as the reference level changes to limit the signal level to the first mixer, as specified by the setting of the **MAX MXR LEVEL** softkey. (**MAX MXR LEVEL** is a spectrum analyzer softkey located in a menu displayed by pressing **MENU**.) The signal level to the mixer is limited to avoid amplitude inaccuracies and damage to the receiver.

---

**Note** Because an RF or microwave spectrum analyzer can be damaged easily when input attenuation is not present, input attenuation below 10 dB can be set only with the numeric keypad or a remote programming command.

---

To change the attenuation level, press **RF ATTN AutoMan** so that **Man** is underlined, and enter the desired level of attenuation. When the reference-level and attenuation functions are uncoupled, an asterisk appears next to **ATTEN** on the analyzer display. Press **RF ATTN AutoMan** so that **Auto** is underlined to recouple the functions.

## RF/IF Gain:

Parameter displayed on receiver personality's screen. The displayed value represents the amount of gain applied to the input signal from the front-panel **RF INPUT** connector to the Option 001 rear-panel 70 MHz output connector. The rear-panel 321.4 MHz IF output level is 5 dB higher than the 70 MHz output. The 140 MHz IF output level is 10 dB lower than the 70 MHz output.

If an HP 70620B preamplifier *is not* present, the **RF/IF Gain** is expressed by the following equation:

$$RF/IF\ Gain = IF\ gain - RF\ attenuation$$

where:

*IF gain* (implemented in the HP 70911A ultra wide-bandwidth IF section) is a value from 0 to 70 dB. IF gain can be set from the receiver personality or from the `Amptd` softkey accessed by pressing `MENU`.

*RF attenuation* (implemented in the HP 70910A RF section) is a value from 0 to 65 dB. It is set within the receiver personality or from the `Amptd` softkey accessed by pressing `MENU`.

IF gain steps are in 10 dB increments. RF attenuation is in 5 dB increments.

If an HP 70620B preamplifier *is* present, the RF/IF Gain is expressed by the following equation:

$$RF/IF\ Gain = IF\ gain - RF\ attenuation + preamplifier\ gain - preamplifier\ correction$$

where:

*preamplifier gain* is nominally 28 dB. However, at some frequencies, it is a more and at others is less.

*preamplifier correction* factor is the offset value from 28 dB of preamplifier gain. The maximum correction factor is generally 6 dB but is usually around 1 dB or 2 dB.

Note that when you turn the preamplifier on, the RF attenuator is automatically set to a value roughly enough to compensate for the preamplifier gain. The RF attenuation may change from 10 dB to 35 dB or 45 dB when the preamplifier is turned on; this helps to protect the mixer accidental damage. If the level is safe enough, you can then reduce RF attenuation to 10 dB to actually realize the preamplifier's benefit of a lower noise floor.

The receiver personality only sets the correct values of RF/IF gain for the HP 70910A and HP 70909A RF sections and *not* the HP 70908A. The HP 70908A RF section does not have a programmable gain amplifier and therefore the equation would not be the same.

#### `save & recall`

Displays a menu for saving and recalling receiver-state files. State files record the current setting of the instrument. When recalled, these files restore the receiver to the saved settings. Receiver-state files can be saved to internal memory, a memory card, or an HP-IB disk drive.

#### `SAVE RX STATE`

Saves the receiver's current state in a file. Recalling the file restores the receiver to the saved settings.

#### `SIG LVL On Off`

Turns on or off a display of the signal's average amplitude level. The average is computed at the end of every sweep. Use the `units menu` softkey to select the amplitude units that are displayed.

### SIGNAL TRACK

Allows the receiver in search mode to automatically maintain drifting signals at the center of the screen. As the signal drifts, the spectrum analyzer is returned to bring the signal and marker to the center of the screen. This allows real-time monitoring of the change.

### SPAN

Changes the total display frequency range symmetrically about the center frequency.

### SPAN

This receiver personality softkey allows you to temporary view the spectrum without leaving the personality. The receiver mode's default frequency span is 0 Hz. After pressing this softkey, use the front-panel knob, step keys, or numeric keypad to enter the desired frequency span. To return to fixed-tuned operation, enter a span of 0 Hz.

When the span is changed from 0 Hz and the **IF BW AutoMan** softkey is set to Auto, the IF bandwidth is coupled to the span and may change.

### START FREQ

Sets the start frequency at the left side of the display. Use the **START FREQ** and **STOP FREQ** keys to define the frequency measurement range of the horizontal axis. The measurement range of the horizontal axis can also be set using the **CENTER** and **SPAN** keys.

### STOP FREQ

Sets the stop frequency at the right side of the display. Use the **START FREQ** and **STOP FREQ** keys to define the frequency measurement range of the horizontal axis. The measurement range of the horizontal axis can also be set using the **CENTER** and **SPAN** keys.

### temp compens

Displays a menu with instructions on how to run the HP 70911A temperature compensation routine. This routine decreases temperature induced errors, improves the fidelity of the video detector, and reduces DC offsets on the internal FM assembly. Running this routine requires that you first connect the front-panel 300 MHz **CALIBRATOR** output to the **RF INPUT** connector. Run this routine whenever the ambient air temperature has changed by 5°C or more since the last front-panel calibration. This routine is automatically performed as part of the front-panel calibration as described in Chapter 3 of this manual.

Do not run this temperature compensation routine if you have manually adjusted the FM offset as part of the customer calibration.

## TITLE

Allows you to write a short description before saving the current state in a file.

## units menu

Displays a menu for selecting the amplitude units used for the displayed average signal level. To view the average signal level, turn **SIG LVL On Off** so that **On** is underlined. Normally, the receiver personality automatically selects the units.

## USER

Front-panel key that presents the **USER** menu. The **USER** menu displays softkeys for any advanced measurement program. For example, the receiver personality is accessed through this menu by pressing **RX\_MODE**.

## VBW/IFB RATIO

Specifies the ratio between the video and IF bandwidths that is maintained when their settings are coupled. The default value is 0.3.

$$\text{video bandwidth} = (\text{resolution bandwidth})(0.5)$$

The ratio can be set between  $10^{-100}$  and  $10^{+100}$ .

## VID BW AutoMan

Specifies the width of the video-bandwidth filter and controls the coupling between the IF bandwidth and video-bandwidth filter settings. With **Auto** underlined, the receiver automatically selects a bandwidth based on the video-to-IF bandwidth ratio of 0.3. Use the **VBW/IFB RATIO** softkey to change the default video-to-IF bandwidth ratio. When **Man** is underlined, the video bandwidth is decoupled from the IF bandwidth and can be manually set.

## VID OUT TO L.O.

Rear-panel connector on the HP 70911A module. This video output signal goes to the HP 70900B's rear-panel **VIDEO IN** connector.

## VIDEO

Front-panel connector on the HP 70911A module. This output provides the 10 kHz to 100 MHz wide-bandwidth video signal.

## **VOLT**

Displays the average value of the signal in volts.

## **WATT**

Displays the average value of the signal in watts.

## **WB VID IN**

Rear-panel connector on the HP 70911A module. This input signal connects to the rear-panel WB VID OUT connector.

## **WB VID OUT**

Rear-panel connector on the HP 70911A module. This output signal goes to the rear-panel WB VID IN connector.



## Programming Commands

---

This chapter documents the commands that are used to control the receiver personality. When these commands are combined with the commands documented in the *HP 70000 Modular Spectrum Analyzer Programming Manual*, you have all the commands that are used to program the instrument.

Both the receiver personality commands and the HP 70900B commands are sent to the address of the HP 70900B module as described in Chapter 4 of this manual.

### Contents

Syntax Conventions .....	8-2
Softkeys Versus Commands .....	8-4
RXRMT CHANFILT .....	8-6
RXRMT CHANPATH .....	8-7
RXRMT DELETERX .....	8-8
RXRMT DEMOD .....	8-9
RXRMT FMOFF .....	8-11
RXRMT IFGAIN .....	8-12
RXRMT IGAIN .....	8-13
RXRMT INIT .....	8-14
RXRMT IOFFSET .....	8-15
RXRMT OPTIONS? .....	8-16
RXRMT QGAIN .....	8-17
RXRMT QOFFSET .....	8-18
RXRMT QUAD .....	8-19
RXRMT RECALLRX .....	8-21
RXRMT SAVERX .....	8-22
RXRMT TEMPCOMP .....	8-23
RXRMT VERSION? .....	8-24

## Syntax Conventions

Documented with each command is a syntax diagram, a program example, and a complete description. Command syntax is represented pictorially as shown in the following figure.

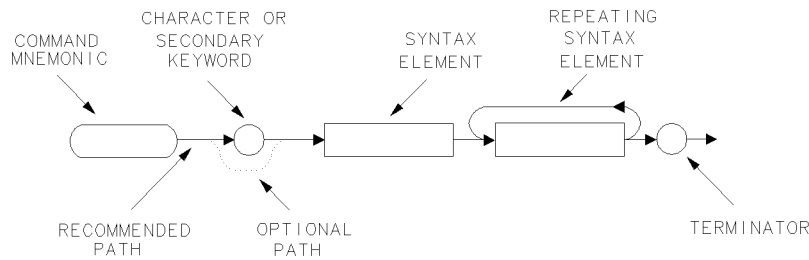

- Characters enclosed by an oval are commands and their arguments and must be entered *exactly as shown*.
- Characters enclosed by a circle are separators or terminators and must be entered as shown.



Syntax-diagram elements are connected by solid and dotted lines. Any combination of elements generated by following the lines in the proper direction is correct syntactically. *Solid-line paths are recommended.*

The following two tables define the syntax diagram elements used in this manual.

### Terminators, Separators, and Commonly Used Arguments

Item	Description
,	Comma. ASCII-decimal number 44.
;	Semicolon. ASCII-decimal number 59.
S <sub>P</sub>	Space. ASCII-decimal number 32.
C <sub>R</sub>	Carriage return. ASCII-decimal number 13.
L <sub>F</sub>	Line feed. ASCII-decimal number 10.
DN	Down. Change function value by step increment. Simulates press of  key.
UP	Up. Change function value by step increment. Simulates press of  key.
EP	Enter parameter. Suspend program operation until number is entered with front-panel controls (step keys, knob, or numeric keypad.) Pressing <b>ACCEPT VALUE</b> enters the number and resumes program operation.
?	Query. Returns current value of function to computer.
TRA	Select trace A for operation.
TRB	Select trace B for operation.
TRC	Select trace C for operation.

Syntax Diagram Elements

Syntax Component	Definition/Range
<i>character</i>	SP * . < = > @ ^ {   } ~ ! " # \$ % & ' ( ) + , . / 0 1 2 3 4 5 6 7 8 9 : ; A B C D E F G H I J K L M N O P Q R S T U V W X Y Z [ \ ] ? `   a b c d e f g h i j k l m n o p q r s t u v w x y z _
<i>compatible function</i>	Any spectrum-analyzer command in this chapter that operates on other functions.
<i>data byte</i>	8-bit byte containing numeric or character data.
<i>data byte &amp; EOI</i>	8-bit byte containing numeric or character data sent with end-or-identify (EOI) condition, where the EOI control line on HP-IB is asserted to indicate the end of the transmission.
<i>delimiter</i>	~   \ @ = < > / ^ \$ % ! ' ; " & Matching characters that mark the beginning and end of a character string, or a list of user-defined functions or analyzer commands. To avoid misinterpretation, choose delimiting characters that are not also within the string they delimit.
<i>digit</i>	0 1 2 3 4 5 6 7 8 9
<i>number</i>	Expressed as integer, decimal, or in exponential (E) form. Real Number Range: $\pm 1.797,693,134,862,315 \times 10^{308}$ , including 0. Up to 15 significant figures allowed. Numbers may be as small as $\pm 2.225,073,858,507,202 \times 10^{-308}$ Integer Number Range: -32,768 through +32,767
<i>output termination</i>	Line feed (LF) with end-or-identify (EOI) condition. ASCII code 10 (line feed) is sent via HP-IB, with the end-or-identify control line on HP-IB set to indicate the end of the transmission.
<i>units</i>	Represent standard scientific units. Amplitude Units: DB, DBM, MW, NW, PW, UW, W Current Units: A, MA, UA Frequency Units: HZ, KHZ, MHZ, GHZ, KZ, MZ, GZ Time Units: S, MS, US, SC Wavelength Units: ANG, KM, NM, UM, PM

## Syntax Conventions

# Softkeys Versus Commands

### Softkeys versus Commands

Softkey	Equivalent Programming Command	Definition
1.25 MHz	RXRMT CHANPATH	Selects the 1.25 MHz channel filter on an option board.
5 MHz	RXRMT CHANPATH	Selects the 5 MHz channel filter on an option board.
10 MHz	RXRMT CHANPATH	Selects the 10 MHz channel filter on an option board.
20 MHz	RXRMT CHANPATH	Selects the 20 MHz channel filter on an option board.
36 MHz	RXRMT CHANPATH	Selects the 36 MHz channel filter on an option board.
70 MHz	RXRMT CHANFILT,70E6?	Returns a list of available filters for the 70 MHz option board.
140 MHz	RXRMT CHANFILT,140E6?	Returns a list of available filters for the 140 MHz option board.
70911 OPTIONS	RXRMT OPTIONS?	Returns a list of installed options.
A UNITS AutoMan	AUNITS <sup>1</sup>	Selects units for amplitude annotation and data.
AM	RXRMT DEMOD,AM	Selects demodulation of amplitude modulated signals.
BW		Displays a menu for changing bandwidth values.
CENTER	CF <sup>1</sup>	Activates the center frequency tuning.
channel filters	RXRMT CHANFILT?	Displays menu for selecting channel IF filters.
CF STEP AutoMan	SS <sup>1</sup>	Sets the center frequency step size.
dBm	AUNITS DBM <sup>1</sup>	Displays the average value of the signal in decibels relative to 1 milliwatt.
dBmV	AUNITS DBMV <sup>1</sup>	Displays the average value of the signal in decibels relative to 1 millivolt.
dBuV	AUNITS DBUV <sup>1</sup>	Displays the average value of the signal in decibels relative to 1 microvolt.
DEL RX STATE	RXRMT DELETERX	Deletes a receiver state file that has been previously saved using the <code>save rx state</code> softkey.
Demod		Displays a menu for selecting the type of demodulation used.
DISPLAY On Off	GRAT OFF;TRDSP TRA,OFF <sup>1</sup>	Use this softkey to turn off the display of traces and the graticule.
FM NB	RXRMT DEMOD,FMNB;RXRMT FMOFF,NB,2048	Selects the FM narrowband discriminator, and adjusts the FM narrowband discriminator's offset DAC.
FM WB	RXRMT DEMOD,FMWB;RXRMT FMOFF,WB,2048	Selects the FM wideband discriminator, and adjusts the FM narrowband discriminator's offset DAC.
Freq		Displays a menu for changing the measurement frequency and the span.
FULL SPAN	IP <sup>1</sup>	Restores spectrum analyzer mode with full span.
Gain		Displays a menu for controlling receiver gain, attenuation, amplitude units
Help On Off		Turns online help on and off.
HP-MSIB CARD	MSI CARD <sup>1</sup>	Accesses various types of external memory available via HP-MSIB.
HPIB DISK	MSI HPIB <sup>1</sup>	Selects external memory accessed via HP-IB
I GAIN	RXRMT IGAIN	Adjusts signal gain applied to front-panel I output (Option 004).
I OFFSET	RXRMT IOFFSET	Adjusts dc offset at front-panel I output (Option 004).
IF GAIN AutoMan	RXRMT IFGAIN	Sets the amount of IF <sup>2</sup> gain applied to the signal.
IF BW	RB <sup>1</sup>	Specifies the width of the IF bandwidth.
INTRNL MEMORY	MSI INT <sup>1</sup>	Specifies saving files to internal memory.

<sup>1</sup> Refer to the *HP 70000 Modular Spectrum Analyzer Programming Manual for HP 70900B Local-Oscillator-Controlled Modules*.

## Softkeys versus Commands (continued)

Softkey	Equivalent Programming Command	Definition
IQ	RXRMT DEMOD,IQ	Selects demodulation of IQ modulated signals.
LAST STATE	LOAD "SA_s_0" <sup>1</sup>	Restores last used spectrum analyzer settings.
Misc		Displays a menu of miscellaneous receiver functions.
NARROW SPAN	MPY SP,10,RB; <sup>1</sup>	Restores spectrum analyzer mode with narrow span.
PRESEL On Off	PSENABLE <sup>1</sup>	Turns preselector on and off.
PULSE	RXRMT DEMOD,PULSE	Selects demodulation of pulse-modulated signals.
Q GAIN	RXRMT QGAIN	Adjusts signal gain applied to front-panel Q output (Option 004).
Q OFFSET	RXRMT QOFFSET	Adjusts dc offset at front-panel Q output (Option 004).
QUAD RATURE	RXRMT QUAD	Adjusts the phase between the front-panel I and Q outputs.
RCL RX STATE	RXRMT RECALLRX	Reconfigures the receiver into a state that has been saved in a receiver-state file.
RECEIVER VERSION	RXRMT VERSION?	Displays the date code of the receiver program.
Return to S/A		Displays menu to restore spectrum analyzer mode.
RF ATTN AutoMan	AT <sup>1</sup>	Varies RF input attenuation
RX MODE	RXRMT INIT	Initializes receiver mode but does not display receiver menus.
SAVE RX STATE	RXRMT SAVERX	Saves the receiver's current state in a file.
save & recall		Displays a menu for saving and recalling receiver-state files.
save rx state		Displays a set of instructions for saving the RX state in a file.
SIG LVL On Off		
SPAN	SP <sup>1</sup>	Changes frequency span.
temp compens	RXRMT TEMPCOMP	Performs a temperature compensation routine.
TITLE	TITLE <sup>1</sup>	Allows you to write titles on the screen in an area reserved for titles.
units menu	AUNITS <sup>1</sup>	Displays a menu for selecting the average amplitude units.
VBW/IFB RATIO	VBR <sup>1</sup>	Specifies the coupling ratio between the video and IF bandwidths.
VID BW AutoMan	VB <sup>1</sup>	Changes video bandwidth.
VOLT	AUNITS V <sup>1</sup>	Displays the average value of the signal in volts.
WATT	AUNITS W <sup>1</sup>	Displays the average value of the signal in watts.

<sup>1</sup> Refer to the *HP 70000 Modular Spectrum Analyzer Programming Manual for HP 70900B Local-Oscillator-Controlled Modules*.

## RXRMT CHANFILT

Queries a list of available channel IF filters.

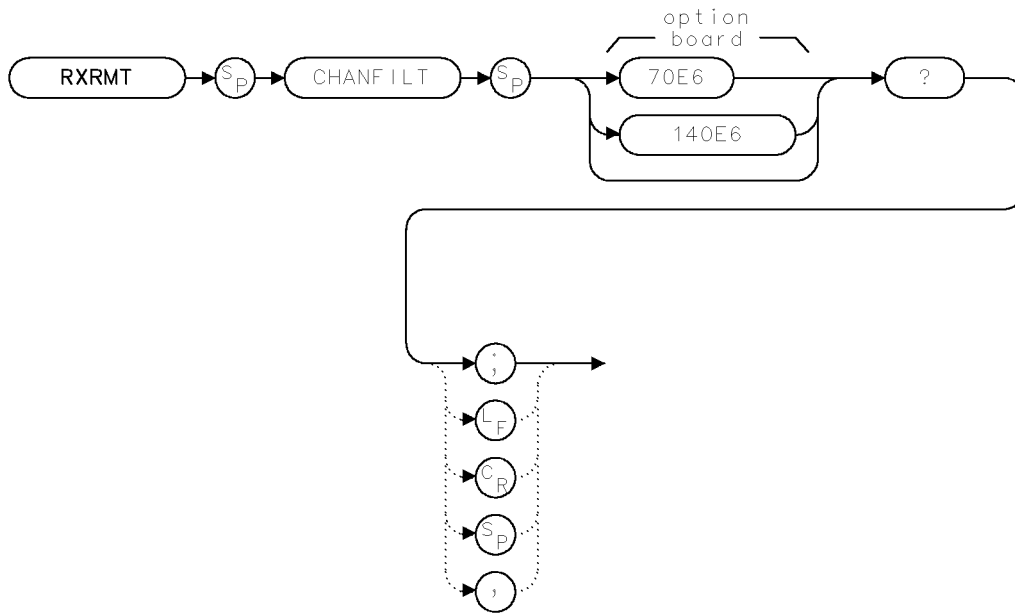

xcfilt

### Example

```

OUTPUT 718;"RXRMT CHANFILT 70E6?;"   Query the filters in the 70 MHz filter path.
ENTER 718; FILTERS$
  
```

### Description

The RXRMT CHANFILT command returns to the controller a list of all optional IF boards or all channel filters on a specific option board. Items in the returned list are separated by commas.

#### Required Instrument Options

IF Path	Required Option
70 MHz	Option 001
140 MHz	Option 002

Query Response

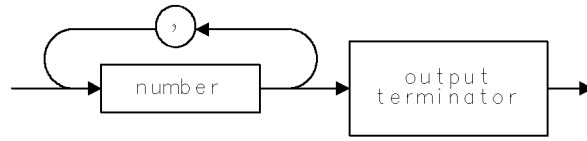

qcfilt . .

# RXRMT CHANPATH

Selects a filter or queries the channel filter that is currently active on an option board.

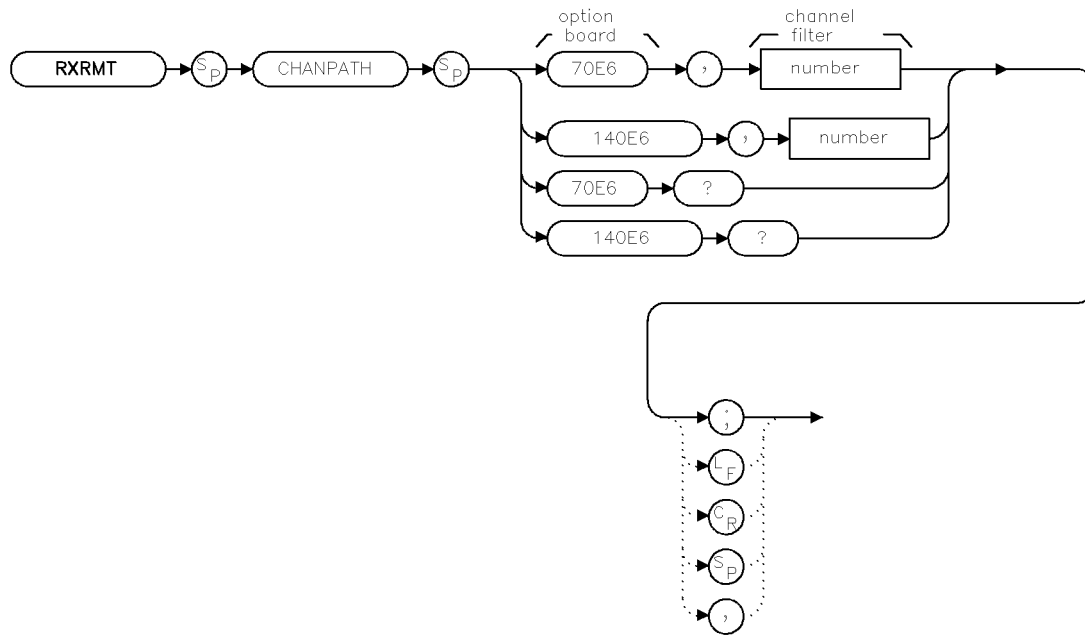

xcpath

## Example

```

OUTPUT 718;"RXRMT CHANPATH 140E6,5E6;"      Select the 5 MHz filter.
OUTPUT 718;"RXRMT CHANPATH 140E6?;"        Query the selected filter in the 140 MHz path.
ENTER 718; Path$
OUTPUT 718;RXRMT CHANPATH 70E6,0;          Select the through path on the 70 MHz option board.
  
```

## Description

The RXRMT CHANPATH command selects an IF channel filter that is loaded on an option board. The following channel filters are available in the 70 MHz option path:

- 1.25 MHz
- 5 MHz
- 10 MHz
- 20 MHz
- 36 MHz

You can select a “through” path by sending an argument that specifies a 0 MHz filter. The RXRMT CHANPATH command can also be used to query the active filter on the 70 MHz or 140 MHz option boards. (These options are filter cards installed in the HP 70911A wide bandwidth IF module.) You must specify which IF path that the filter is located: 70 MHz or 140 MHz.



**Query Response**

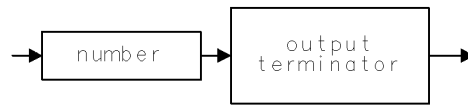

qcpath ...

**See Also**

RXRMT CHANFILT

---

## RXRMT DELETERX

Deletes a receiver state file that has been previously saved.

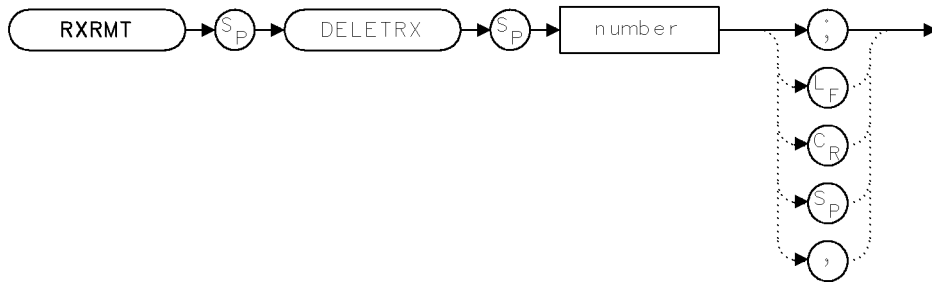

xdelet .

Item	Description
number	An integer between 1 and 999.

### Example

```
OUTPUT 718;"MSI INT;"           Selects internal memory.  
OUTPUT 718;"RXRMT DELETERX 7;" Deletes file number 7.
```

### Description

The RXRMT DELETERX command erases a receiver state file from default memory. Use the HP 70900B's MSI command to select the location of default memory.

### See Also

RXRMT RECALLRX and RXRMT SAVERX

# RXRMT DEMOD

Selects the demodulation.

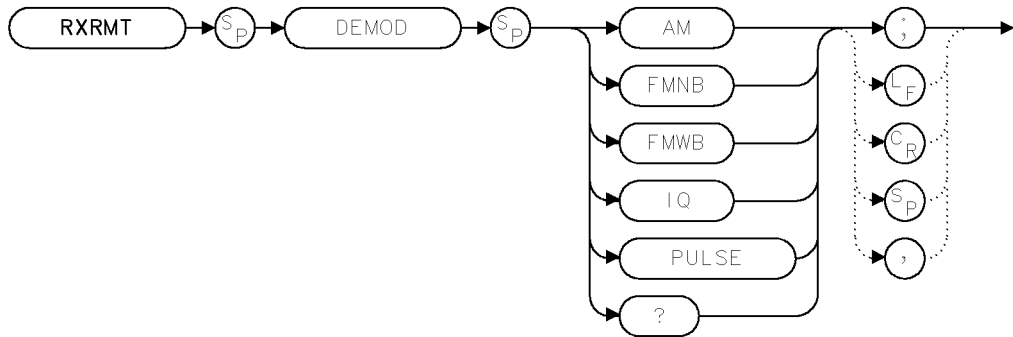

x demo d

Item	Description
Preset State	AM

## Example

```
OUTPUT 718;"RXRMT DEMOD IQ;"
```

## Description

AM and pulse demodulation formats are always available. FM wideband, FM narrowband, and IQ demodulation require the options shown in the following table. The default demodulation is AM. When pulse demodulation is selected, the video bandwidth is changed to 100 MHz.

### Required Instrument Options

Demodulation	Required Option
I/Q	Option 004 Analog I/Q output
FM	Option 005 FM output

The FM discriminators have the following characteristics:

±5 MHz Narrowband discriminator:

FM Sensitivity ..... 0.1 V/MHz  
 Maximum output ..... ±0.5V

±20 MHz Wideband discriminator:

FM Sensitivity ..... 0.025 V/MHz  
 Maximum output ..... ±0.5V

**RXRMT DEMOD**

**Query Response**

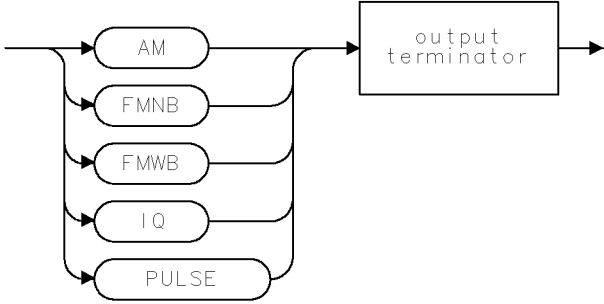

qdemo d

## RXRMT FMOFF

Adjusts the FM discriminator's output to zero volts.

**Note** In order to use this command, Option 005, FM output, must be installed in the HP 70911A module.

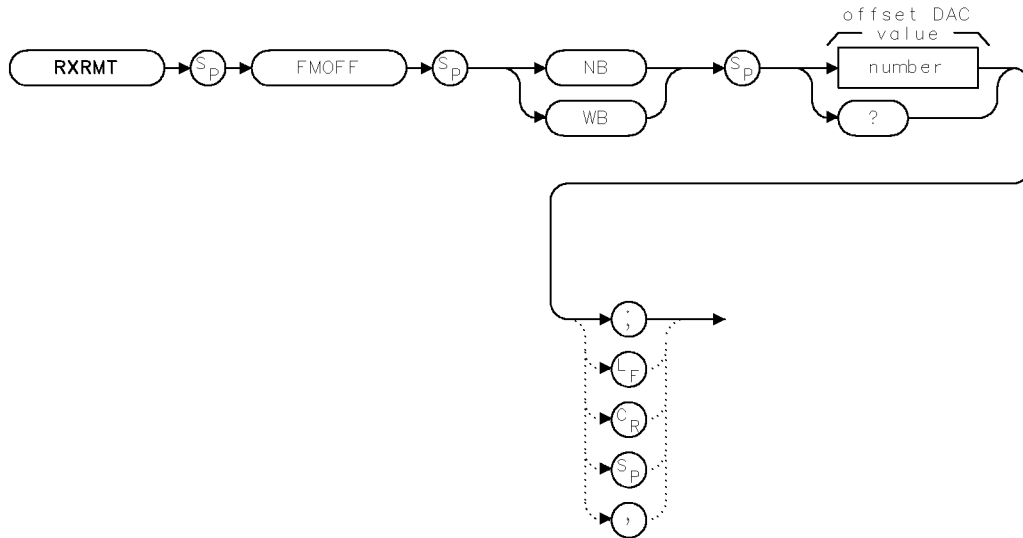

x f m o f f

Item	Description
Adjustment range	0 to 4095
Preset value	2048

### Example

```
OUTPUT 718;"RXRMT DEMOD FMNB;"      Select narrowband discriminator.
OUTPUT 718;"RXRMT FMOFF NB 2092;"    Adjust discriminator's dc output.
```

### Description

The RXRMT FMOFF command adjusts the FM narrowband or wideband discriminator's output to 0 volts. The command's argument represents a unitless digital-to-analog (DAC) value. The default settings is 2048. You must specify either the narrowband (NB) or wideband (WB) discriminator with this command.

To adjust the discriminator, input an unmodulated signal to the receiver, and select FM wideband or narrowband demodulation. Then, while monitoring the dc voltage output at the front-panel FM output connector, send the RXRMT FMOFF command to vary the value for an output of 0V.

RXRMT FMOFF

**Query Response**

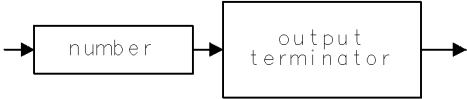

qfmo f f

## RXRMT IFGAIN

Adjusts the amount of IF gain applied to the signal.

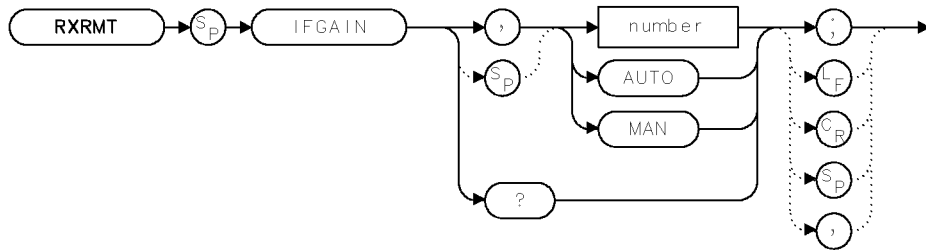

xifgain .

Item	Description
Adjustment range	The range of values allowed for this command are signal path, and thus hardware, dependent.
Preset value	Step-gain value minus the HP 70911A calibration attenuation.

### Example

OUTPUT 718;"RXRMT IFGAIN 20;" *Select 20 dB of gain.*

### Description

The RXRMT IFGAIN command is used to query or select the amount of IF gain applied to the signal. When AUTO is selected, the receiver automatically selects the proper value.

### Query Response

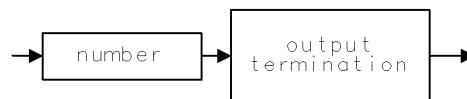

qgennum .

## RXRMT IGAIN

Adjusts the signal gain applied at the front-panel I output.

**Note** In order to use this command, Option 004, Analog I/Q output, must be installed in the HP 70911A module.

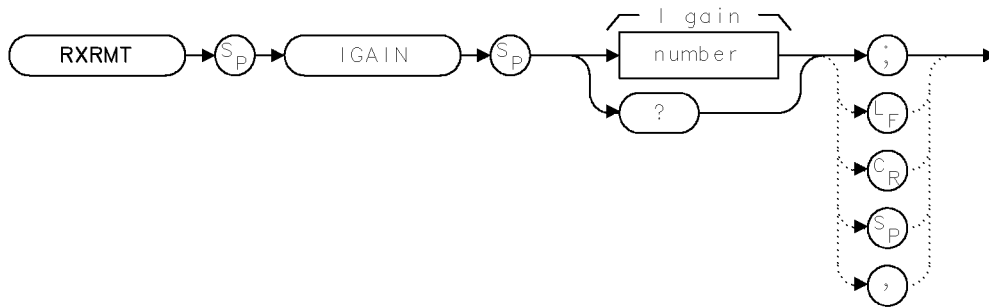

xigain

Item	Description
Adjustment range	0 to 4095
Preset value	2048

### Example

```
OUTPUT 718;"RXRMT IGAIN 2074;"
```

### Description

The RXRMT IGAIN command can be used during IQ demodulation to adjust the gain present on the I output to equal the gain on the Q output. The command's argument represents a unitless digital-to-analog (DAC) value. The default settings is 2048.

### Query Response

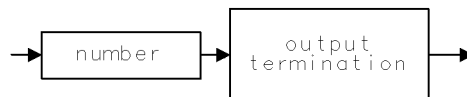

qgennum

### See Also

RXRMT DEMOD and RXRMT QGAIN



---

## RXRMT INIT

Starts and initializes receiver program.

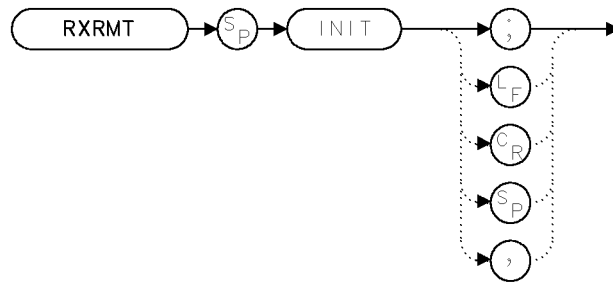

xinit

### Example

```
OUTPUT 718;"RXRMT INIT;"
```

### Description

The RXRMT INIT command starts the receiver program and initializes it. It must always be the first command that you send to the receiver program. You do not have to manually start the program (by pressing **USER** and then **RX\_MODE**) before sending this command. In fact, your programs will run faster if you do *not* manually start the program. This is due to the time that is required to update the display.

If you want the receiver program displayed while under remote control, manually start the program, and then continue controlling the program remotely.

If the program is exited at any time, this command must be used to reinitialize the program before any receiver commands can be sent again.

---

**Note** Always send this command before sending any other programming commands that are documented in this book.

---

## RXRMT IOFFSET

Adjusts the dc voltage offset at the front-panel I connector to zero volts.

**Note** In order to use this command, Option 004, Analog I/Q output, must be installed in the HP 70911A module.

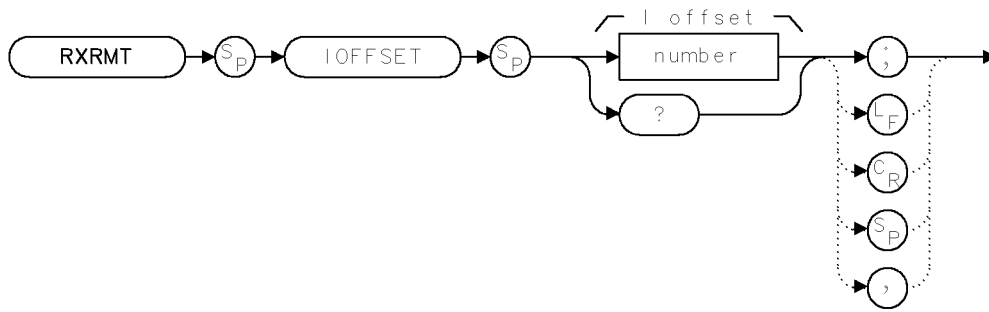

xioset

Item	Description
Adjustment range	0 to 4095
Preset value	2048

### Example

```
OUTPUT 718;"RXRMT IOFFSET 2095;"
```

### Description

The RXRMT IOFFSET command adjusts the I output during IQ demodulation to 0 volts. The command's argument represents a unitless digital-to-analog (DAC) value. The default settings is 2048.

To adjust the output, input an unmodulated signal to the receiver, and select IQ demodulation. Then, while monitoring the dc voltage output at the front-panel I connector, send the RXRMT IOFFSET command to vary the value for an output of 0V.

### Query Response

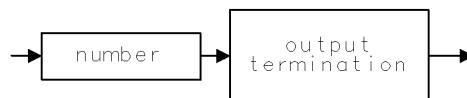

qgennum

### See Also

RXRMT DEMOD and RXRMT QOFFSET

# RXRMT OPTIONS?

Returns a list of installed options.

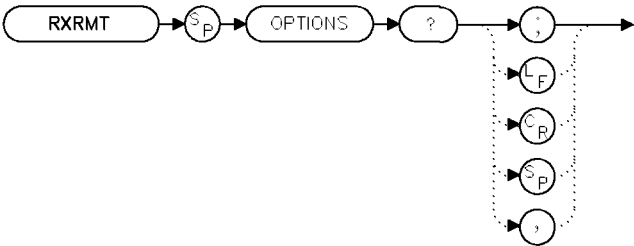

xoptns

## Example

```

OUTPUT 718;"RXRMT OPTIONS?;"    Query the option numbers in the HP 70911A.
ENTER 718;Options$;
  
```

## Description

The RXRMT OPTIONS? command returns a list of the HP 70911A options that are currently installed in the system. The returned ASCII string consists of comma separated numbers that correspond to the descriptions that are shown in the following table.

### Option Numbers Returned by OPTIONS?

ASCII Number	Description
001	70 MHz IF output
002	140 MHz IF output
004	Analog IQ output
005	FM output

## Query Response

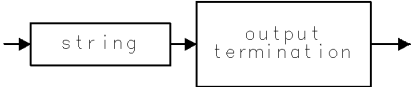

qstray

## RXRMT QGAIN

Adjusts the signal gain applied at the front-panel Q output.

**Note** In order to use this command, Option 004, Analog I/Q output, must be installed in the HP 70911A module.

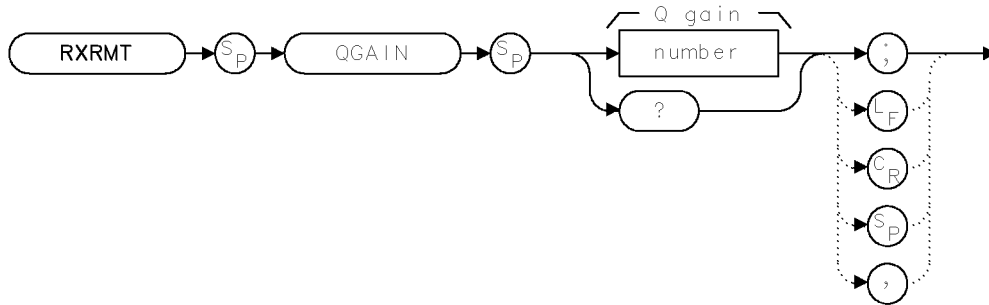

xqgain

Item	Description
Adjustment range	0 to 4095
Preset value	2048

### Example

```
OUTPUT 718;"RXRMT QGAIN 2010;"
```

### Description

The RXRMT QGAIN command can be used during IQ demodulation to adjust the gain present on the Q output to equal the gain on the I output. The command's argument represents a unitless digital-to-analog (DAC) value. The default settings is 2048.

### Query Response

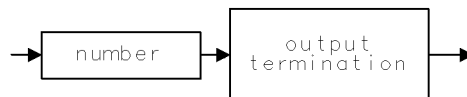

qqennum

### See Also

RXRMT DEMOD and RXRMT IGAIN

## RXRMT QOFFSET

Adjusts the dc voltage offset at the front-panel Q output connector to zero volts.

**Note** In order to use this command, Option 004, Analog I/Q output, must be installed in the HP 70911A module.

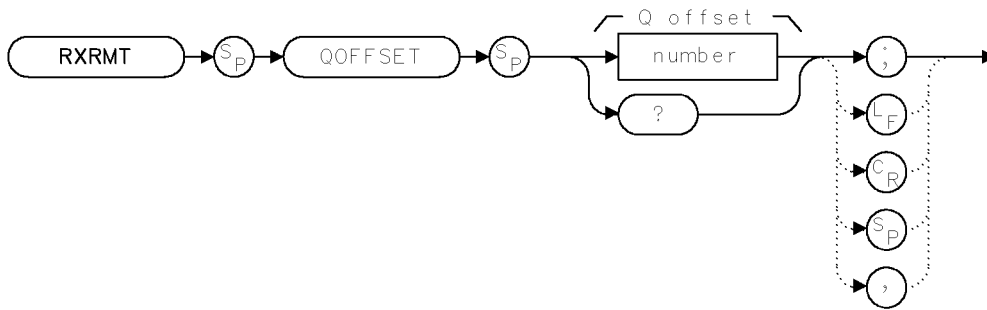

xqoset

Item	Description
Adjustment range	0 to 4095
Preset value	2048

### Example

```
OUTPUT 718;"RXRMT QOFFSET 2095;"
```

### Description

The RXRMT QOFFSET command adjusts the Q output to 0 volts. The command's argument represents a unitless digital-to-analog (DAC) value. The default settings is 2048.

To adjust the output, input an unmodulated signal to the receiver, and select IQ demodulation. Then, while monitoring the dc voltage output at the front-panel Q connector, send the RXRMT QOFFSET command to vary the value for an output of 0V.

### Query Response

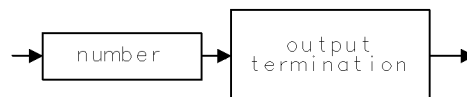

qqennum

### See Also

RXRMT DEMOD and RXRMT IOFFSET

---

## RXRMT QUAD

Adjusts the phase between the front-panel I and Q outputs.

---

**Note** In order to use this command, Option 004, Analog I/Q output, must be installed in the HP 70911A module.

---

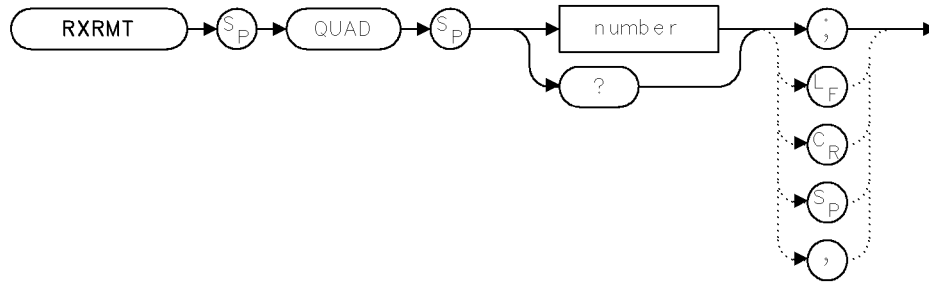

Item	Description
Adjustment range	0 to 4095
Preset value	2048

### Example

```
OUTPUT 718;"RXRMT QUAD 1080;"
```

### Description

The RXRMT QUAD (quadrature) command adjusts the phase difference between the Option 004 analog I/Q outputs to 90°. Use this adjustment to optimize the shape of constellations that are displayed on an oscilloscope. For example, if the displayed constellation is elliptical in shape instead of circular, adjust the quadrature setting. The adjustment values are unitless numbers that range from 0 to 4095.

## Query Response

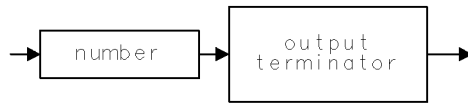

qqquad

## See Also

RXRMT DEMOD

---

## RXRMT RECALLRX

Reconfigures the receiver into a state that has been saved in a receiver-state file.

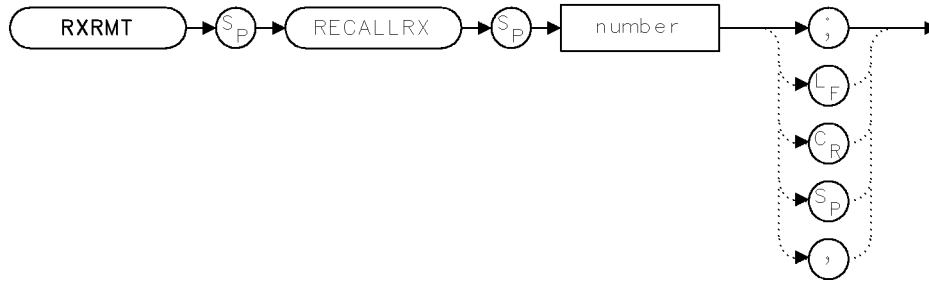

xrecall

Item	Description
number	An integer between 1 and 999.

### Example

```
OUTPUT 718;"MSI INT;"           Selects internal memory.
OUTPUT 718;"RXRMT RECALLRX 8;"  Recalls file number 8.
```

### Description

The RXRMT RECALLRX command recalls a receiver state file from default memory. Use the HP 70900B's MSI command to select the location of default memory.

### See Also

RXRMT SAVERX and RXRMT DELETERX



## RXRMT SAVERX

Writes a receiver state to a file.

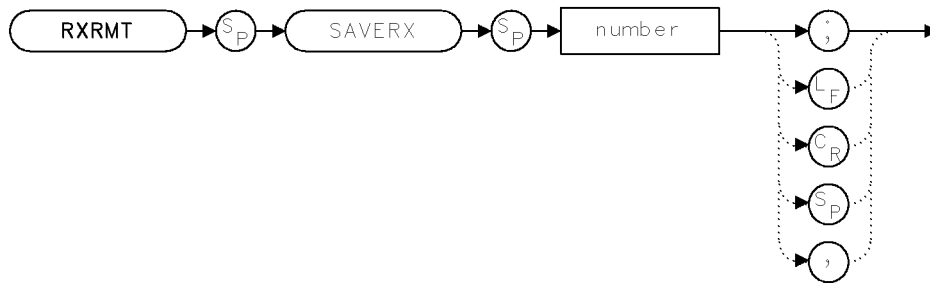

xsave

Item	Description
number	An integer between 1 and 999.

### Example

```

OUTPUT 718;"MSI INT;"           Selects internal memory.
OUTPUT 718;"RXRMT SAVERX 2;"    Saves state in file number 2.
  
```

### Description

The RXRMT SAVERX command saves a receiver state file from internal memory to default memory. Use the HP 70900B's MSI command to select the location of default memory.

### See Also

RXRMT RECALLRX and RXRMT DELETERX

---

## RXRMT TEMPCOMP

Runs a temperature compensation routine.

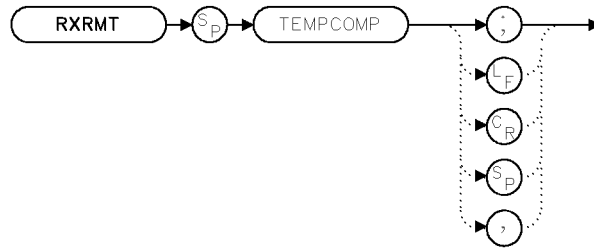

x t p cmp

### Example

```
OUTPUT 718;"RXRMT TEMPCOMP;"
```

### Description

Decreases temperature induced errors, improves the fidelity of the video detector, and reduces DC offsets on the internal FM assembly. Running this routine requires that you first connect the front-panel 300 MHz CALIBRATOR output to the RF INPUT connector. Run this routine whenever the ambient air temperature has changed by 5°C or more since the last front-panel calibration.

## RXRMT VERSION?

Returns the version of the receiver program.

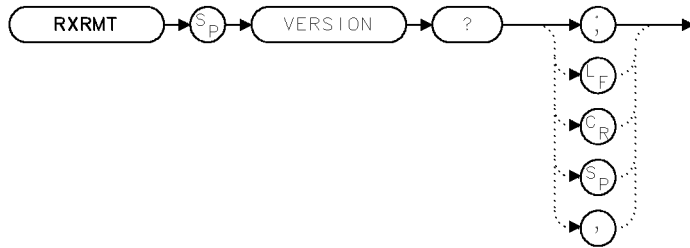

xversn

### Example

```

OUTPUT 718;"RXRMT VERSION?;"
ENTER 718;STRING$;
  
```

### Description

The RXRMT VERSION? command returns the version number of the receiver program.

### Query Response

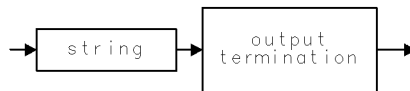

qstrqy



## Error Messages

---

This chapter provides a list of receiver specific error messages and troubleshooting information. For definitions of general error messages not found in this manual, refer to the *HP 70000 Modular Spectrum Analyzer Installation and Verification Manual*.

Error messages can be the result of incorrect operating procedures, illegal programming commands, or hardware failures. Normally, the instrument removes error messages from the screen as soon as the error conditions are corrected. If you have a computer, error messages can also be retrieved via HP-IB by executing the **ERR?** programming command. Refer to the *HP 70000 Modular Spectrum Analyzer Programming Manual* for information on the **ERR?** command and programming.

### Contents

Error Message Descriptions .....	9-2
Troubleshooting Features .....	9-6

---

**Note** For complete troubleshooting instructions related to the HP 70207A PC Display for MMS, the MSIB interface card, and the MSIB Y-cable, refer to the *HP 70207A User's Guide*.

---

---

## Error Message Descriptions

For a complete listing of HP 71910A error messages, refer to the *HP 70000 Modular Spectrum Analyzer Programmer's Guide for HP 70900B Local-Oscillator-Controlled Modules*.

### **3100 Can't get {string name}**

Part of the receiver personality is missing. Try reloading the personality. Or, contact an HP service representative.

### **3101 Enter # >=0 & <=4095**

The parameter used must be between 0 and 4095.

### **3102 Can't alloc {string name}**

Memory is not available for the requested allocation.

### **3103 Not enough parameters**

A receiver personality command is missing an argument.

### **3104 Bad handle size**

The size of a data allocation is not what it should be. Contact an HP service representative.

### **3105 Can't find 70911**

An HP 70911A module is not present in the system.

### **3106 FM Discr not present**

Option 005 FM output is not installed in the HP 70911A module. You must install Option 005 before using any of the following programming commands:

```
RXRMT FMNB  
RXRMT FMWB  
RXRMT FMOFF
```

### **3107 Invalid input param**

An illegal input parameter was sent with a receiver personality command.

### **3108 Enter integer > 0**

An illegal attempt was made to enter an integer less than zero.

### **3109 Can't write {string name}**

The receiver personality cannot create the receiver-state file specified by the RXRMT SAVERX command. Check to see if memory is available to write the file.

### **3110 Can't read {string name}**

The receiver-state file specified in the RXRMT RECALLRX command cannot be read.

### **3111 Can't open {string name}**

The receiver state file specified in the RXRMT RECALLRX command cannot be located. Either the file does not exist or default memory is not properly selected. Use the HP 70900B's MSI command to select default memory. Use the HP 70900B's DSPTEXT CAT? command to catalog the contents of the selected default memory.

**3112 Enter integer < 1000**

An illegal attempt was made to enter an integer greater than 1000.

**3113 Wrong 70900 firmware**

The firmware revision of the HP 70900A local oscillator module does not support the receiver personality commands.

**3114 No channel filters**

No channel filters have been detected by the system. Check that the **RXRMT INIT** command has been executed which will find any channel filters that are present.

**3116 IQ optn not present**

Option 004 Analog I/Q output is not installed in the HP 70911A. An attempt was made to use an Option 004 feature without the required hardware.

**3117 Unsupported scrn siz**

The screen size is too small to properly display the HP 71910A Receiver personality.

**3118 Screen too small**

The screen size is too small to display the graticule and trace.

**3119 Signal too low**

The highest peak is too low to perform the desired function.

**3120 Signal too high**

The highest peak is too high to perform the desired function.

**3121 Wrong 70900 firmware**

The firmware revision of the HP 70911A wide-bandwidth IF module does not support the selected function.

**3194 Send-only keyword**

An illegal attempt was made to query data from the receiver personality. The errant programming command can not be used to query data; look for an improper ? character.

**3195 Query-only keyword**

A programming command has been sent to the receiver personality which is missing a ? character. This command can only be used to query data.

**3196 Missing Rx parm**

An incomplete programming command was sent to the receiver personality. Check the commands with the definitions given in Chapter 8 to determine the missing parameter.

**3197 Missing parameter**

An incomplete programming command was sent to the receiver personality. Check the commands with the definitions given in the *HP 70900A Programmer's Guide for HP 70900B Instruments*.

**3198 Parm out of range**

An attempt was made to set a parameter outside its allowable range.

**3199 Illegal Rx keyword**

An incorrect programming command was sent to the receiver personality. Check for typographical errors. Make sure that each receiver personality command is preceded by RXRMT. Refer to Chapter 8 for a complete description of each receiver personality command.

**6020 Sys Offset > 100mV**

During a calibration, the offset voltage at the HP 70911A's rear panel VID OUT TO L0 connector is greater than 100 mV. A linear detector calibration is not performed. The calibration measures the offset voltage. If the offset is greater than 100 mV, the calibration is stopped.

**6021 Sys Offset Corr > 60**

Could not correct for offset at the HP 70911A's rear panel VID OUT TO L0 connector.

**6022 FM Offset > 250mV**

The offset voltage at the HP 70911A's front panel FM connector is too high. If the offset is greater than 250 mV, the calibration stops.

**6023 FM Offset Corr > 200**

Could not correct for offset at the HP 70911A's front panel FM connector.

**7080 70MHz LO Unlocked**

The 70 MHz downconverter's LO is unlocked. Check that the 300 MHz input signal is present.

**7081 140MHz LO Unlocked**

The 140MHz downconverter's LO is unlocked. Check that the 300 MHz input signal is present.

**7082 160MHz LO Unlocked**

The 160MHz downconverter's LO is unlocked. Check that the 300 MHz input signal is present.

**7083 LO Board Unlocked**

The IQ's LO is unlocked. Check that the 300 MHz input signal is present.

**7084 Filter Not Present**

The channel filter board is broken or is not installed.

**7085 Table Not Pres**

A programming error occurred during alignment where an attempt was made to write the wrong alignment data table.

**7086 Align Data**

A programming error occurred during alignment where an attempt was made to write the wrong alignment data table.



**7087 Duplicate Table**

A programming error occurred during alignment. Alignment data table not identical.

**7088 CAP STRING**

A programming error occurred during alignment. The `cap` string was not input.

**7089 EAROM full error**

A programming error occurred during alignment.

---

## Troubleshooting Features

The receiver has two types of front-panel status indicators. The ERR (error) indicators indicates a fault of some kind. The ACT (active) indicator shows that the receiver is active, controlled, or accessed. In addition, four indicators flag HP-IB activities:

- RMT (remote)
- LSN (listen)
- TLK (talk)
- SRQ (service request)

A fault in a receiver lights the ERR indicator. The ERR indicator goes out when the fault condition is cleared and is reported. A fault in the receiver also causes the appearance of the E indicator on the display.

An ERR indicator flashing slowly at about 1 Hz means the receiver cannot communicate on the HP-MSIB. The module is probably defective if the ERR (Error) indicator is flashing in this manner.

When the address map cursor is at the address of an element, the element's active indicator lights. It is thus possible to determine an element's address by scrolling through the map.

## Tables and Charts

---

### Contents



Instrument Options .....	10-2
Accessories Supplied with the Product .....	10-2
Line-power Cables .....	10-3
Hewlett-Packard Sales and Service Offices .....	10-4

### Instrument Options

Option	Description
001	70 MHz IF output
002	140 MHz IF output
004	Analog IQ output
005	FM output
007	70 MHz IF channel filters (requires Option 001)
011	Single mainframe configuration (deletes HP 70004A, 70902A, and 70903A)
012	Option 011 plus HP 70310A
013	Option 011 plus HP 70902A
014	Option 011 plus HP 70903A
015	Option 011 plus HP 70500A real-time controller
016	Option 011 plus HP 70620B Option 001 preamplifier (100 kHz - 26.5 GHz)
017	Option 011 plus HP 70620B preamplifier (1 GHz - 26.5 GHz)
100	Delete HP 70902A IF from standard configuration
101	Delete HP 70903A IF from standard configuration
110	Delete HP 70310A IF from standard configuration
121	Add distribution amplifier to HP 70310A
122	Delete oven from HP 70310A
200	Delete HP 70004A display/mainframe
205	Substitute HP 70205A display
400	Add 400 Hz power line frequency operation to HP 70001A mainframe
660	Adds HP 8566B programming manual
810	Rack mount slide kit for both HP 70001A mainframe and HP 70004A display/mainframe
0B1	Extra user manual set
0B3	Service manual and software
AX4	Rack flange kit to mount HP 70001A mainframe and HP 70004A display/mainframe without handles.
AXE	Rack flange kit to mount HP 70001A mainframe and HP 70004A display/mainframe with handles.

### Accessories Supplied with the Product

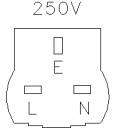
Accessory	Qty	HP Part Number
Receiver Personality 3.5-inch diskette	1	70911-10001
Receiver Personality ROM card	1	70911-10002

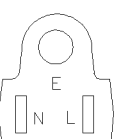
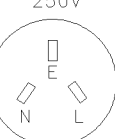
PLUG TYPE **	CABLE HP PART NUMBER	PLUG DESCRIPTION	CABLE LENGTH CM (INCHES)	CABLE COLOR	FOR USE IN COUNTRY
250V 	8120-1351 8120-1703	Straight* BS1363A 90°	229 (90) 229 (90)	Mint Gray Mint Gray	Great Britain, Cyprus, Nigeria, Singapore, Zimbabwe
250V 	8120-1369 8120-0696	Straight* NZSS198/ASC112 90°	201 (79) 221 (87)	Gray Gray	Argentina, Australia, New Zealand, Mainland China
250V 	8120-1689 8120-1692	Straight* CEE7-Y11 90°	201 (79) 201 (79)	Mint Gray Mint Gray	East and West Europe, Central African Republic, United Arab Republic (unpolarized in many nations)
125V 	8120-1348 8120-1538	Straight* NEMA5-15P 90°	203 (80) 203 (80)	Black Black	United States Canada, Japan (100 V or 200 V), Brazil, Colombia, Mexico, Phillipines, Saudia Arabia, Taiwan
	8120-1378 8120-4753	Straight* NEMA5-15P Straight	203 (80) 230 (90)	Jade Gray Jade Gray	
	8120-1521 8120-4754	Straight 90° 90°	203 (80) 230 (90)	Jade Gray Jade Gray	
250V 	8120-5182 8120-5181	Straight* NEMA5-15P 90°	200 (78) 200 (78)	Jade Gray Jade Gray	Israel
<p>* Part number for plug is industry identifier for plug only. Number shown for cable is HP Part Number for complete cable, including plug.</p> <p>** E = Earth Ground; L = Line; N = Neutral.</p>					

FORMAT80

## Line-power Cables

**Table 10-1. Hewlett-Packard Sales and Service Offices**

<b>US FIELD OPERATIONS HEADQUARTERS</b>	<b>EUROPEAN OPERATIONS HEADQUARTERS</b>	<b>INTERCON OPERATIONS HEADQUARTERS</b>
Hewlett-Packard Company 19320 Pruneridge Avenue Cupertino, CA 95014, USA (800) 752-0900	Hewlett-Packard S.A. 150, Route du Nant-d'Avril 1217 Meyrin 2/Geneva Switzerland (41 22) 780.8111	Hewlett-Packard Company 3495 Deer Creek Rd. Palo Alto, California 94304-1316 (415) 857-5027
<b>California</b> Hewlett-Packard Co. 1421 South Manhattan Ave. Fullerton, CA 92631 (714) 999-6700  Hewlett-Packard Co. 301 E. Evelyn Mountain View, CA 94041 (415) 694-2000	<b>France</b> Hewlett-Packard France 1 Avenue Du Canada Zone D'Activite De Courtaboeuf F-91947 Les Ulis Cedex France (33 1) 69 82 60 60	<b>Australia</b> Hewlett-Packard Australia Ltd. 31-41 Joseph Street (P.O. Box 221) Blackburn, Victoria 3130 (61 3) 895-2895
<b>Colorado</b> Hewlett-Packard Co. 24 Inverness Place, East Englewood, CO 80112 (303) 649-5000	<b>Germany</b> Hewlett-Packard GmbH Hewlett-Packard-Strasse 61352 Bad Homburg Germany (+49 6172) 16-0	<b>Canada</b> Hewlett-Packard (Canada) Ltd. 17500 South Service Road Trans-Canada Highway Kirkland, Quebec H9J 2X8 Canada (514) 697-4232
<b>Georgia</b> Hewlett-Packard Co. 2124 Barrett Park Drive Kennesaw, GA 30144 (404) 955-1500	<b>Great Britain</b> Hewlett-Packard Ltd. Eskdale Road, Winnersh Triangle Wokingham, Berkshire RG11 5DZ England (44 734) 696622	<b>Japan</b> Yokogawa-Hewlett-Packard Ltd. 1-27-15 Yabe, Sagamihara Kanagawa 229, Japan (81 427) 59-1311
<b>Illinois</b> Hewlett-Packard Co. 5201 Tollview Drive Rolling Meadows, IL 60008 (708) 342-2000		<b>China</b> China Hewlett-Packard, Co. 38 Bei San Huan X1 Road Shuang Yu Shu Hai Dian District Beijing, China (86 1) 256-6888
<b>New Jersey</b> Hewlett-Packard Co. 150 Green Pond Road Rockaway, NJ 07866 (201) 586-5400		<b>Singapore</b> Hewlett-Packard Singapore Pte. Ltd. Alexandra P.O. Box 87 Singapore 9115 (65) 271-9444
<b>Texas</b> Hewlett-Packard Co. 930 E. Campbell Rd. Richardson, TX 75081 (214) 231-6101		<b>Taiwan</b> Hewlett-Packard Taiwan 8th Floor, H-P Building 337 Fu Hsing North Road Taipei, Taiwan (886 2) 712-0404

## Configuring and Addressing

---

This chapter presents a basic addressing principles for HP 70000 Series modular systems. It does not contain installation information for the HP 71910A wide-bandwidth surveillance receiver. Refer to Chapter 1 for installation information.

The factory ships HP 70000 Series modular systems with all system components installed and addressed. All cables, however, are subject to removal for shipment. An **element** in an HP 70000 modular measurement system is a **system component** able to communicate with other modules over HP-MSIB. Element addresses must adhere to the set of rules defined in this section. HP-MSIB addressing is different from HP-IB addressing, and is explained in this chapter. Correct addressing requires an understanding of the concepts in this chapter.

### Contents

Modular Measurement System Terms .....	11-2
Address Map Protocol .....	11-4
Addressing Elements .....	11-6
Addressing Order Requirements .....	11-9
Address Switches .....	11-13

---

## Modular Measurement System Terms

Understanding the following terms is essential to understanding HP-MSIB addressing and the structural relationship of modular measurement system devices.

### Functional Terms

The devices of a modular system may be combined in such a way to allow them to communicate and operate as an instrument. The following terms identify the interrelationship among devices within a modular instrument.

#### Element

Any device that communicates over the HP-MSIB (for example, HP 70902A IF section). In contrast, the HP 70001A mainframe controls all HP-MSIB communication, but does not communicate over the HP-MSIB and therefore is not an element.

#### Master

An element that controls other elements.

#### Sub-master

An element that simultaneously controls other elements and is controlled by another element.

#### Slave

An element that is controlled by another element.

#### Independent element

An element that is neither a master nor a slave (for example, HP 70004A color display).

#### Instrument

A module, or group of modules, that performs an independent function (for example, HP 71910A receiver).

### Structural Terms

Modular systems consist of hardware structures dedicated to specific functions. The structural terms used in reference to these functions are described below.

#### Mainframe

A housing for modules which also provides power, cooling, interconnection for HP-MSIB and HP-IB, and HP-MSIB communications control for up to eight 1/8-width modules. The HP 70004A color display also provides the same functions for up to four 1/8-width modules.

#### Module

Modules are devices that plug into an HP 70001A mainframe or HP 70004A color display. Modules cannot function without these independent elements.

## 11-2 Configuring and Addressing



**Stand-Alone Instrument**

An HP-MSIB element capable of performing its functions without a mainframe or HP 70004A color display.

---

## Address Map Protocol

Protocol for master, sub-master, slave, and independent element addressing is explained in this section. The factors governing proper system communication and system function are based on adherence to the addressing protocol of modular spectrum analyzers.

By definition, a master is an element addressed to control another element, or is the controlling element of a system. Slave elements are addressed within the area a master controls, called the slave area. Independent elements are addressed so that they are neither masters nor slaves, though they may have functions that appear to control other elements. For example, the graphics display front panel keys are used to select LO functions, but the LO is not a slave to the display.

### Address Matrix

The address matrix is a graphic representation of assigned and available HP-MSIB addresses. The address assigned to each element appears on the matrix and indicates the relationship among master, sub-master, slave, and independent elements. Module function, access to HP-IB communication, and error reporting are all based on the location of the module address on the matrix. See the following figure. The 8-row by 32-column matrix implies that 256 addresses are available; however, there are actually 255 legal addresses plus an illegal address at row 0, column 31.

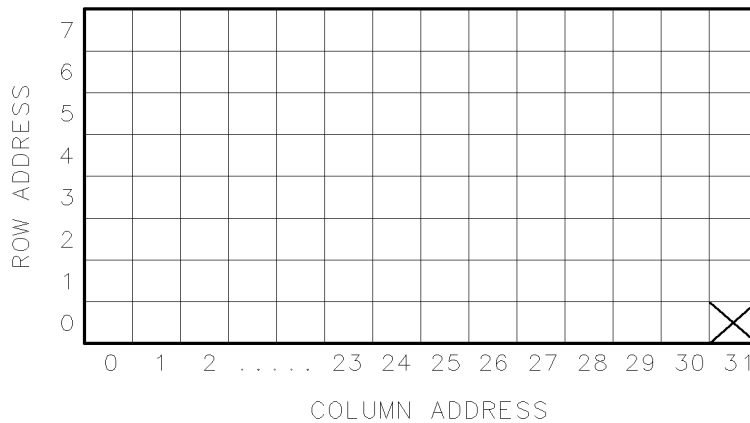

**Address Matrix**

Each element must have a unique 8-bit binary HP-MSIB address correctly placed on the address matrix. The three most significant bits (MSB) determine the row address; the five least significant bits (LSB), the column address. This manual refers to the decimal equivalent of a binary address.

#### Decimal Equivalent of Binary Address

	Row MSB	Column LSB
<b>Binary</b>	010	11000
<b>Decimal</b>	2	24

## Display-Response Area

A display-response area exists at row 0. The display's **REPORT ERRORS** menu key function can only access a module addressed at row 0. A display must be assigned to an instrument before communication between the two is initiated. This can be done automatically or manually. The automatic assignment function (**SELECT INSTRUMENT** menu key) searches the display-response area (row 0) when it assigns itself to an instrument. The display can be assigned to a module at any other row, but this assignment must be done manually using the **ASSIGN KEYBOARD** and **ASSIGN WINDOW** menu keys.

---

**Note** To be addressed at row 0, a module must be designed to interface with the display and report errors. If a module that does not have these capabilities is addressed at row 0, the system will cease to communicate.

---

## HP-IB Access

The HP-IB access area is at row 0 of the address matrix. Address row 0, column 31, however, is an illegal address location for any element. Modules that have been designed for HP-IB access are able to use HP-IB only if their addresses are in the HP-IB access area (row 0, columns 0 through 30).

---

**Note** Address row 0, column 31 is an illegal address for any element.

---

# Addressing Elements

## Master Elements

The address switches set an element's HP-MSIB address. If the element is a master or an independent element, the column switches also determine the default HP-IB address. (Displays do not have row address switches, so they are always set to row address 0.) A master is typically placed at any legal row 0 address. This row address location allows error reporting and access to HP-IB. If neither error reporting nor HP-IB access are required, a master may be placed at any legal address.

Modules controlled by another module are called slaves. To be controlled by a master, slave modules must be addressed within the slave area defined by that master. Refer to the following figure for examples of modules in a slave area. For proper system function and communication, slaves must be addressed within the boundaries set by the defining elements.

A defining element is any element, residing to the right and in the same row or lower than a master.

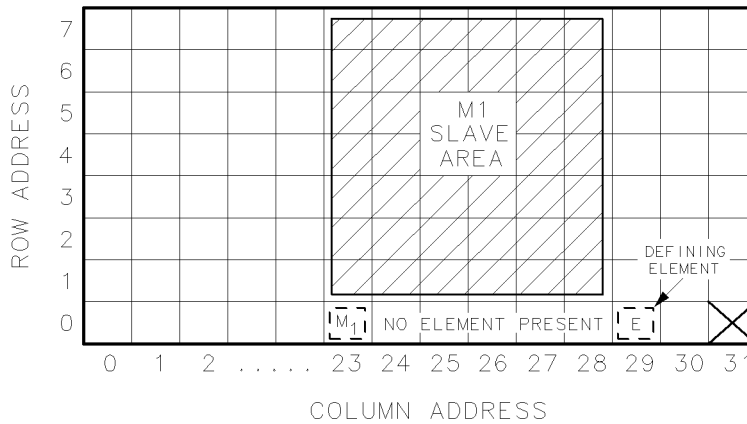

DUA34

**Master/Slave Address Matrix**

## Sub-Master Elements

A sub-master is an element that can function as both master and slave at the same time. Sub-masters are located at a row address other than 0, are controlled by another master, and control a slave area of their own. For example, the following figure illustrates sub-master M2 at address 3, 24. M2 is a slave to M1. M2 also has a slave area that lies within the slave area of M1. M1 does not communicate directly with M2 slaves; it can only communicate with them through M2.

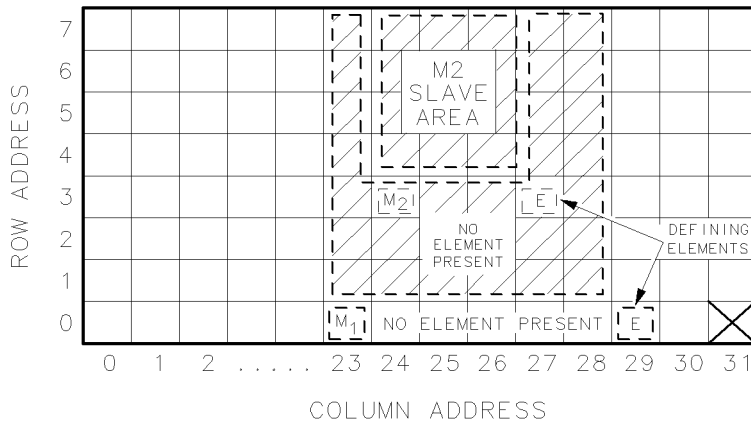

DUA35

**Sub-Master Address Matrix**

### Slave Elements

For an instrument to function properly, the master must determine the slave area it controls on the address matrix. Master modules establish their slave area by determining the location of the defining element on the address matrix. The defining element establishes the boundaries of the slave area. Any module located within this area is a slave to the master module.

The HP-MSIB address requirements of a defining element are as follows:

- The column address of a defining element must be greater than the column address of the master. In the previous *Master/Slave Address Matrix* figure, for the master addressed in column 23, the defining element must be addressed in column 24 or above. In the previous *Sub-Master Address Matrix* figure, for M2 addressed in column 24, the defining element must be addressed in column 25 or above.
- The row address of a defining element must be equal to or less than the row address of a master. In the *Master/Slave Address Matrix* figure the address of the master at row 0 has a defining element addressed at row 0. The *Sub-Master Address Matrix* figure shows two masters, M1 and M2. The defining element for M1 is located at row 0 and the defining element for M2 is located at row 3.

### Slave Area Boundaries

The master determines its slave-area boundaries by first searching upward in its own column starting in the master's row, then in each higher column starting in the master's row. The search stops at the boundary column or, if there is no defining element, after searching column 31.

After a master locates the defining element of its slave area, the slave area boundaries are set by using the following criteria:

- The column address of the master is the left-hand boundary of the slave area. In the *Master/Slave Address Matrix* figure, the left-hand boundary is column 23.
- The right-hand boundary of the slave area is equal to one less than the column address of the defining element. For the master at column 23 in the *Master/Slave Address Matrix* figure, the right-hand boundary is at column 28. If there is no defining element, the right-hand boundary of the slave area extends through column 31.

- The lower boundary of the slave area is one row greater than the row address of the master. For the master in row 0 in the *Master/Slave Address Matrix* figure, the lower boundary is at row 1.
- The upper boundary of the slave area is the top row of the matrix (row 7).

If a new module is added to the area labeled “No Element Present” in the *Master/Slave Address Matrix* figure, this module becomes the new defining element and the right-hand boundary moves toward the master.

### **Independent Elements**

An independent element, such as a display, is neither a master nor a slave. Displays are considered independent elements and separate instruments. Because they do not have row address switches, displays automatically are at row address 0. The typical address for a display is row 0, column 4.

---

## Addressing Order Requirements

HP-MSIB addresses are set by switches located on each module. The address consists of two parts: a row number and a column number. A module's address can be determined by viewing the address map or selecting the configuration screen.

Measurement systems are composed of more than one module. When this is true, the modules will assume master/slave relationships to simplify the user interface. Each master has specific slave addressing requirements and expectations.

The HP 70900B local oscillator source is the master of many possible spectrum analyzer system configurations. It will automatically configure itself into a system with the slaves that it finds available in its slave area on the address map. It searches for these slaves with a specific pattern and expects to find them in a certain order.

The HP 70900B local oscillator source searches the address map by starting in the column where it is addressed and looking for a module in the row directly above it. It continues to look up that column row by row until it reaches the top. It then moves to the next column to the right. Again, it begins its search at the row above its own location, searching up the column to the top. It continues this process until it has searched its entire slave area. In this way it identifies the slave modules that it will configure into a system. For a more detailed description of how a master's slave area is defined, refer to "Address Map Protocol" in this chapter.

### Default Addressing for Configured HP 70000 Systems

Default addresses have been set up to allow for current and future addressing considerations. The use of these default addresses will permit adding additional modules to a system with a minimum of address manipulation. Individual modules shipped from the factory will have their HP-MSIB address set as defined in the default address map.

### Addressing Criteria

Each module, or type of module, has addressing criteria that impact address selection. The descriptions below are written as if the modules are in the same column; however, this is not a requirement as long as their relative position is maintained with respect to the HP 70900B local oscillator source search pattern.

#### HP 70900B local oscillator source

A single HP 70900B local oscillator source master module may control up to 16 slave modules.

#### HP 70902A IF section

The HP 70902A IF section, if present, must be closest to the local oscillator (that is, the HP 70902A IF section should be immediately above the HP 70900B local oscillator source in the address map. It must be the first module that the HP 70900B local oscillator source finds when it searches the slave area.)

### **HP 70700A digitizer**

When the HP 70700A digitizer is present and used as a slave to the HP 70900B local oscillator source, it should be addressed above the HP 70902A IF section (if present). It should also be addressed below the HP 70903A IF section (if present).

### **HP 70911A ultra-wide bandwidth IF section**

When both HP 70902A and HP 70903A IF sections are present, the HP 70911A must be placed at a column address that is between these two modules.

### **HP 70903A IF section**

The HP 70903A IF section, if present, should be above the HP 70902A IF section. It should be the next module that the HP 70900B local oscillator source finds when it searches the slave area. If the HP 70902A IF section is not present, the HP 70903A IF section should be above the local oscillator. If all three of the previously mentioned modules are present when the HP 70900B local oscillator source searches the slave area, it should find the HP 70902A IF section, then the HP 70700A digitizer, and then the HP 70903A IF section.

### **HP 70907B**

An HP 70907B should be addressed immediately below the RF section. Multiple external mixer interface modules should follow each other in the addressing order.

### **RF section**

Only one RF Section may be used with a single HP 70900B local oscillator source. The RF section should be immediately above the IF sections or external mixer interface module.

### **HP 70600A preselector/HP 70601A preselector**

The HP 70600A preselector/HP 70601A preselector, if present, should be immediately above the HP 70905B or HP 70906B. It should normally be the next module that the HP 70900B local oscillator source finds after the RF section when it searches the slave area.

### **HP 70300A RF tracking generator**

The HP 70300A RF tracking generator should be addressed just above an HP 70301A microwave tracking generator, if one is present.

### **HP 70301A microwave tracking generator**

The HP 70301A microwave tracking generator should be addressed just below an HP 70300A RF tracking generator, if one is present.

### **HP 70310A precision frequency reference**

The HP 70310A precision frequency reference may be addressed anywhere.

### **HP 70621A or HP 70620B preamplifiers**

The preamplifiers should be addressed above the module that it is providing preamplification for. Multiple preamplifier modules may be used in the same system. When the HP 70900B local oscillator source searches its slave area, each preamplifier must be found above the module (for example, RF section, preselector, preamplifier) that its output is connected to.

## **11-10 Configuring and Addressing**



## Row Addressing Priority

The row addressing priority for systems is shown below. Notice that this order is a *relative* row-address ranking only. The individual modules do not require consecutive row addresses (that is, there can be empty rows between modules). Also, note that all modules need not be in the same column. They need only fall in the slave area of the master module.

### Highest Row

- HP 70620B or HP 70621A preamplifier (only if preamplifying the lightwave section's input signal)
- HP 70310A precision frequency reference
- HP 70300A RF tracking generator
- HP 70301A microwave tracking generator
- HP 70620B or HP 70621A preamplifier (if preamplifying the preselector's or the RF section's input signal)
- HP 70600A preselector or HP 70601A preselector
- HP 70904A RF section, HP 70905A RF section, HP 70905B RF section HP 70906A RF section, HP 70906B RF section HP 70908A RF section, HP 70909A RF section, HP 70910A RF section (one only)
- HP 70907B (several allowed)
- HP 70903A IF section
- HP 70911A WB IF section
- HP 70700A digitizer
- HP 70902A IF section
- HP 70900B local oscillator source (Row 0)

### Lowest Row

---

**Note**

HP-MSIB addresses must be unique. Setting two HP 70000 elements to the same address will create an error and make the local system bus (HP-MSIB) inoperative. If the cursor cannot be moved about within the address map after a module has been readdressed, check to see if two modules have the same row and column address.

---

---

## Address Switches

The row and column address switches set the HP-MSIB address of a module; the column address switch also sets the HP-IB address for masters and independent elements.

To establish proper system function and HP-MSIB communication, each module has an address switch that is set to a binary, 8-bit HP-MSIB address. Each element in a system must be assigned a unique address. The row address of the HP-MSIB address is determined by three address bits, and the column address is determined by five address bits. Each system has 8 row and 32 column addresses. Address row 0, column 31 is an illegal address; therefore, 255 HP-MSIB addresses are available. The decimal equivalents of the binary row and column addresses are referred to throughout this manual. For example, see the table below.

	Row	Column
<b>Binary</b>	010	11000
<b>Decimal</b>	2	24

The following three sections describe the address switch functions for each of the elements and independent elements available.

- Master Address Switches
- Slave Address Switches
- Display Address Switches

The address switches may be found on the top, side, or rear of the modules, and at the rear of the HP 70004A color display and HP 70206A system graphics display. The location of address switches is defined in each element's installation and verification manual.

### Master Address Switches

The HP-MSIB column address is the same as the default HP-IB address of a master. It is defined by the position of the column address switches.

The HP-IB address of any master (for example, HP 70900B local oscillator source) can, under certain conditions, be set from the front panel of a display. At power-up, this address will override the actual address switch settings. For additional information on how to set the HP-IB address from the front panel, refer to *HP 70000 Modular Spectrum Analyzer Operating Manual*.

The following figure is an illustration of address switches found on an HP 70900B local oscillator source.



## Slave Address Switches

The following figure is an illustration of typical address switches found on a slave element.

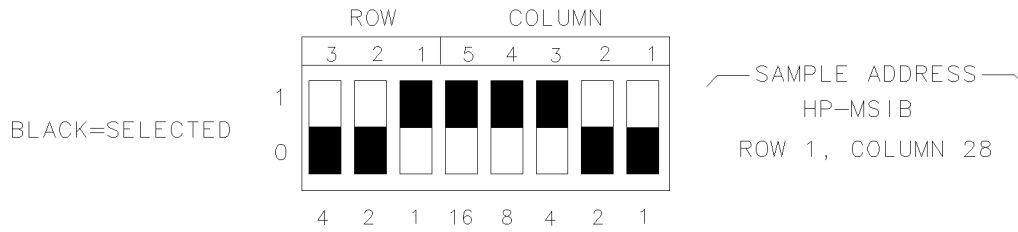

DUA37

**Slave Element Address Switches**

### Rows 1–3

These switches set the HP-MSIB row address.

### Columns 1–5

These switches set the HP-MSIB column address.

## Display Address Switches

A system graphics display is an example of an independent element. It may be assigned both HP-MSIB and HP-IB addresses. The following figures illustrate the address switches of the HP 70004A color display. For more information on HP-MSIB and HP-IB addressing, refer to “Address Map Protocol”.

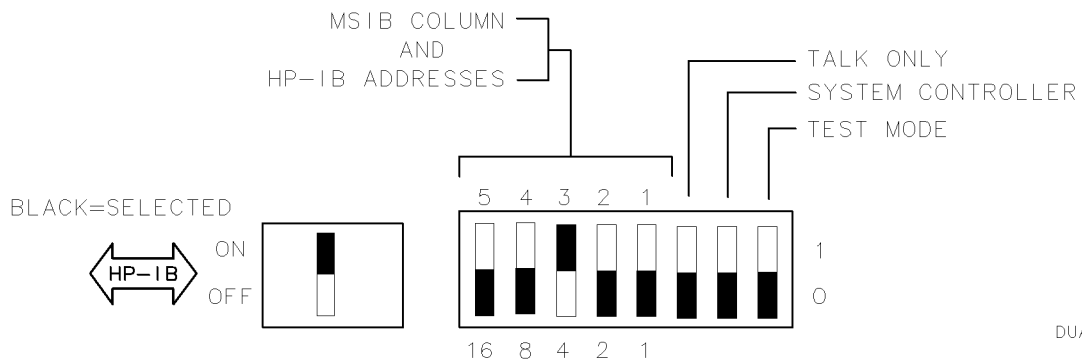

DUA39

**HP 70004A Address Switches**

### HP-IB ON/OFF

This switches the display on or off the HP-IB without disrupting instrument operation.

### A1–A5

These address switches set the HP-MSIB column address, which is also the default HP-IB address. (This HP-IB address is overridden when the HP-IB address is set from the front panel.)

**TALK ONLY**

When this is set to 1 (on) the display can talk on HP-IB without requiring a reply, since some plotters cannot reply. This switch is set to 0 (off) for normal operation.

**SYSTEM CONTROLLER**

When this is set to 1 (on), the display functions as a system controller on HP-IB. This switch is set to 0 (off) at the factory.

**TEST MODE**

When this is set to 1 (on), the display goes into a special test mode at power-up. This switch is set to 0 (off) for normal operation.



# Index

---

## 1

- 10 MHz softkey, 3-24, 7-2
- 1.25 MHz softkey, 3-24, 7-2
- 140 MHz IF
  - connector, 3-16, 3-23
  - maximum bandwidth, 3-26
- 140 MHz OUT connector, 7-2
- 16 QAM Modulation, 3-39

## 2

- 20 MHz softkey, 3-24, 7-2

## 3

- 300 MHz IN connector, 7-3
- 300 MHz OUT connector, 7-3
- 3100 Can't get, 9-2
- 3101 Enter # >=0 & <=4095, 9-2
- 3102 Can't alloc, 9-2
- 3103 Not enough parameters, 9-2
- 3104 Bad handle size, 9-2
- 3105 Can't find 70911, 9-2
- 3106 FM Discr not present, 9-2
- 3107 Invalid input param, 9-2
- 3108 Enter integer > 0, 9-2
- 3109 Can't write, 9-2
- 3110 Can't read, 9-2
- 3111 Can't open, 9-2
- 3112 Enter integer < 1000, 9-3
- 3113 Wrong 70900 firmware, 9-3
- 3114 No channel filters, 9-3
- 3116 IQ optn not present, 9-3
- 3117 Unsupported scrn siz, 9-3
- 3118 Screen too small, 9-3
- 3119 Signal too low, 9-3
- 3120 Signal too high, 9-3
- 3121 Wrong 70900 firmware, 9-3
- 3194 Send-only keyword, 9-3
- 3195 Query-only keyword, 9-3
- 3196 Missing Rx parm, 9-3
- 3197 Missing parameter, 9-3
- 3198 Parm out of range, 9-4
- 3199 Illegal Rx keyword, 9-4
- 321.4 MHz IF connector, 3-16, 3-20
- 321.4 MHz IN connector, 7-3
- 321.4 MHz OPT IN connector, 7-3

- 321.4 MHz OPT OUT connector, 3-20, 7-3
- 321.4 MHz OUT connector, 7-3
- 36 MHz softkey, 3-24, 7-2

## 5

- 5 MHz softkey, 3-24, 7-2

## 6

- 6021 Sys Offset Corr > 60 , 9-4
- 6022 FM Offset > 250mV, 9-4
- 6023 FM Offset Corr > 200 , 9-4

## 7

- 7080 70MHz LO Unlocked, 9-4
- 7081 140MHz LO Unlocked , 9-4
- 7082 160MHz LO Unlocked , 9-4
- 7083 LO Board Unlocked, 9-4
- 7084 Filter Not Present , 9-4
- 7085 Table Not Pres, 9-4
- 7086 Align Data, 9-4
- 7087 Duplicate Table, 9-5
- 7088 CAP STRING, 9-5
- 7089 EAROM full error , 9-5
- 70911 OPTIONS softkey, 7-3
- 70 MHz IF
  - and maximum bandwidth, 3-26
  - connector, 3-23
  - output, 3-16
- 70 MHz OUT connector, 7-2
- 70 MHz softkey, 7-2

## 8

- 8 mm hex-ball driver, 1-15, 1-25

## A

- A1—A5, switches, 11-14
- access area, HP-IB, 11-5
- accessories, 10-2
- active function, 3-6
- active status indicator, 9-6
- ACT status indicator, 9-6
- addressing
  - binary and decimal equivalent, 11-5
  - elements, 11-6
  - HP 70621A preamplifier, 11-10

- HP 70900B local oscillator source, 11-9
- HP 70902A IF section, 11-9
- HP 70903A IF section, 11-10
- HP 70907B, 11-10
- HP 70910A RF section, 1-16
- HP 70911A ultra wide-bandwidth IF section, 1-16
- HP-IB external device, 7-7
- least significant bits, 11-4
- most significant bits, 11-4
- of display, 11-6
- order requirements, 11-9
- override, 11-12
- RF section, 11-10
- switches, 11-6
- addressing criteria
  - HP 70910A RF section, 1-16
  - HP 70911A ultra wide-bandwidth IF section, 1-16
- address map, 1-16, 1-21, 1-26
  - cursor, 9-6
  - protocol, 11-4
- address matrix, 11-4
  - master/slave, 11-6
  - sub-master, 11-7
- address switches
  - column address, 11-12
  - HP 70004A, 11-14
  - HP 70900B local oscillator source, 11-13
  - master, 11-12
  - row address, 11-12
  - slave element, 11-14
- AM connector, 3-25
- amplitude
  - detection, 3-42
  - IF signal, 3-20
  - reference level, 7-14
  - scale, 3-5, 3-7, 3-16
  - units, 3-7, 3-28, 7-4
- Amptd softkey, 3-5
- AM softkey, 3-17, 3-27, 7-4
- analog IQ demodulation, 3-26
- analyzer command, 8-3
- antistatic precautions, 1-15
- ASSIGN KEYBOARD, display menu key, 11-5
- ASSIGN statements, 4-5
- ASSIGN WINDOW, display menu key, 11-5
- assistance, x
- A status indicator, 9-6
- attenuation
  - RF, 3-20, 7-14
- attenuator
  - coupled to reference level, 7-14
  - inability to set to 0 dB, 7-14
  - RF, 7-14

## Index-2

- A UNITS AutoMan softkey, 3-7, 3-28, 7-4
- AUNITS command, 4-7
- average amplitude level, 3-28

## B

- , viii, 7-3
- bandwidth
  - maximum, iv
  - maximum available, 3-43
  - search receiver mode, 3-4
- binary address, decimal equivalent, 11-5
- blanking
  - annotation, 3-52
  - graticules, 3-52
- block diagrams, 3-59
- build window softkey, 3-56
- BW softkey, 3-22, 3-23, 7-4
- BYPASS softkey, 3-24, 7-4

## C

- cables
  - keyboard, 3-53
  - line-power, 10-3
- calibration, 3-3
  - full, 2-1
- CALIBRATOR connector, 3-3
- caution symbol, ix
- CE instrument marking, ix
- , 3-5, 7-4
- center frequency
  - jumps in, 3-13
  - step size, 3-13
- CENTER softkey, 3-6, 7-5
- certification, x
- CF STEP AutoMan softkey, 3-40, 7-5
- channel filters, 3-19
  - softkey, 3-24, 7-5
- chirp, frequency, 3-34
- CLEAR statements, 4-5
- CLEAR TO END softkey, 3-53, 3-57
- collecting signals, 3-14
  - manually, 3-45
- color traces, 3-4
- COLUMNS 1—5, switches, 11-13
- commands
  - HP 70900B, 4-2
  - receiver personality, 4-2
  - required first, 8-17
  - versus softkeys, 8-4
- communication, receiver, 4-5
- compatible function, 8-3
- Config Display softkey, 3-56
- connector
  - FM, 7-6
- constellation, 3-38, 3-68



- diagrams, vi
  - minimizing spinning effect, 3-39
- CONT SWEEP softkey, 3-12
- CSA instrument marking, ix
- custom filters, 3-23
- custom keypad, changing, 1-29

**D**

- data byte & EOI, 8-3
- data transfer, 4-7
- dBm softkey, 3-7, 7-5
- dBmV softkey, 7-5
- dBuV softkey, 7-5
- decimal equivalent, binary address, 11-5
- default
  - addressing, 11-9
  - HP-IB address, 11-6, 11-13
- definition
  - analyzer command, 8-3
  - compatible function, 8-3
  - data byte & EOI, 8-3
  - defining element, 11-7
  - delimiter, 8-3
  - independent elements, 11-4, 11-8
  - master, 11-4
  - number, 8-3
  - output termination, 8-3
  - slave, 11-4, 11-6
  - slave area, 11-7
  - sub-master, 11-4, 11-6
  - units, 8-3
- DELETE or ... softkey, 3-53, 3-57
- delimiter, 8-3
- DEL RX STATE softkey, 3-55, 7-5
- Demod softkey, 3-17, 3-27, 7-5
- demodulating a signal, 3-25
- demodulation, 3-27
  - default, 3-25
  - formats, 3-17
  - IQ, 3-26
  - options, 8-11
  - selecting remotely, 8-11
- discriminators, 3-26
- disk drive
  - addressing, 1-33
  - type, 1-33
- display
  - A1—A5, switches, 11-14
  - address switches, 11-14
  - blanking for security, 3-56
  - cleaner, 1-28
  - HP 70004A windows, 3-52, 3-56
  - HP-IB ON/OFF, switches, 11-14
  - limits with manual collection, 3-43
  - receiver mode, 3-16
  - response area, 11-5
    - selecting memory card or HP-IB disk, 7-7
  - SYSTEM CONTROLLER, switches, 11-15
  - TALK ONLY, switches, 11-15
  - TEST MODE, switches, 11-15
- DISPLAY**, vii, 3-56
- displayed dynamic range, 3-16
- displayed noise, 3-11
  - reducing, 3-11
- display menu key
  - ASSIGN KEYBOARD, 11-5
  - ASSIGN WINDOW, 11-5
  - REPORT ERRORS, 11-5
  - SELECT INSTRUMENT, 11-5
- DISPLAY On Off softkey, 7-6
- display-response area
  - automatic assignment, 11-5
  - manual assignment, 11-5
- ▼**, 7-4
- downconverting, 3-14
  - 2.7 to 26.5 GHz, 3-20
- dynamic range, 3-16, 3-42

**E**

- element, MMS term, 11-1, 11-2
- ENTER LINE softkey, 3-54, 3-57
- ENTER statements, 4-5
- error message, 3-44, 9-2
  - ERR command, 9-1
    - Possible compression, 3-44, 3-66
    - reporting, 9-6
    - UNCAL, 3-44, 3-64, 3-65
    - UNCOR, 3-44, 3-63
    - usable RBW limited, 3-44
    - Usable RBW limited is displayed, 3-64
    - Usable VBW limited is displayed, 3-65
- ERR status indicator, 9-6
- E status indicator, 9-6
- examples, 3-29
  - pulsed RF signal, 3-29, 3-46
  - wide-bandwidth digital transmission, 3-38
  - wide-bandwidth FM signal, 3-34
- EXTEND STATE softkey, 1-14
- external mixers, 3-51

**F**

- file recall, 7-13
- firmware date code, HP 70900B, 1-14
- fixed-tuned operation, 3-14
- FM
  - connector, 3-27, 7-6
  - discriminators, 3-26
  - signals, 3-34
- FM NB softkey, 3-27, 7-6

FM WB softkey, 3-27, 7-6  
 Freq softkey, 3-5, 3-18, 7-6  
 frequency  
   center, 7-4, 7-5  
   changing, 3-6  
   changing in personality, 3-18  
   chirp, 3-34  
   extended range, 3-7  
   menu, 3-5  
   range, 3-5  
   range, extending, 3-51  
   resolution, 3-10  
   returning to full span, 3-7  
   span, 7-16  
   start, 7-16  
   stop, 7-16  
 frequency shift, 3-68  
 front-panel  
   ←, 7-3  
   CENTER, 7-4  
   ▼, 7-4  
   FM connector, 7-6  
   HOLD, 7-7  
   HP-HIL connector, 3-53, 3-57  
   I connector, 7-8  
   INSTR, 7-9  
   LSN indicators, 4-6  
   MENU, 7-10  
   PLOT, 7-11  
   PRINT, 7-12  
   Q connector, 7-12  
   REF LEVEL, 7-14  
   RMT indicators, 4-6  
   SRQ indicators, 4-6  
   START FREQ, 7-16  
   STOP FREQ, 7-16  
   TLK indicators, 4-6  
   ▲, 7-4  
   VIDEO connector, 7-17  
 FULL SPAN softkey, 3-7, 3-18, 7-6  
 functional terms, 11-2  
 fundamental units, 4-7  
 fuse, changing, 1-28

## G

gain  
   analog IQ, 3-26  
   IF, 3-20  
   RF to IF, 3-20, 7-14  
 Gain softkey, 3-23, 3-28, 7-7

## H

hard reset, TEST position, 11-13  
 Help On Off softkey, 3-15, 7-7  
 highest peak, 7-11  
 HOLD, viii, 7-7  
 How to  
   connect the MSIB Y-Cable, 1-9  
 HP 11974 mixers, 3-51  
 HP 11990A System Performance Tests, 2-1  
 HP 54602A oscilloscope, 3-38  
 HP 70001A mainframe  
   physical dimensions, 5-16  
 HP 70004A display/mainframe, 3-56  
   address switches, 11-14  
   cleaning the screen, 1-28  
   external HP-MSIB device, 7-7  
   memory card or HP-IB disk, 7-7  
   physical dimensions, 5-16  
 HP 70620B preamp, 3-49  
 HP 70620B preamplifier, 7-11, 7-14  
 HP 70703A oscilloscope, 3-29  
 HP 70900B local oscillator source  
   address switches, 11-13  
   COLUMNS 1—5, switches, 11-13  
   HP-IB ON/OFF, switches, 11-13  
   MAS/SLA, switches, 11-13  
   NRML/TEST, switches, 11-13  
   ROWS 1—3, switches, 11-13  
   SW1/MEM, switches, 11-13  
 HP 70911A module's rear panel, 3-19  
 HP 71209A, upgrading, 1-14  
 HP DISK softkey, 1-33  
 HP-HIL keyboard, 3-53, 3-57  
 HP-IB  
   addressing external device, 7-7  
   HP 71910A address, 4-3  
   status indicator, 9-6  
 HPIB DISK softkey, 1-33, 3-53, 7-7, 7-13, 7-15  
 HP-IB ON/OFF, switches, 11-14  
 HP-LIF format, 1-31  
 HP-MSIB  
   accessing HP-IB disk, 7-7  
   accessing memory of an external device, 7-7  
   default device address, 7-7  
   row address, setting, 11-13  
   selecting memory card or HP-IB disk, 7-7  
 HP-MSIB CARD softkey, 3-53, 3-55, 7-7, 7-13, 7-15

## I

I  
 I  
   connector, 3-27  
   front panel connector, 7-8  
 IF

- available frequencies, 3-16
- bandwidth, 3-14, 3-22
- digitizer, 3-20
- filters, 8-8
- gain, 3-20, 3-22, 3-23
- outputs, 3-19
- video bandwidth ratio, 3-22
- IF BW softkey, 3-22, 7-8
- IF gain, 3-19
- IF GAIN AutoMan softkey, 3-23, 7-9
- I GAIN softkey, 7-8
- illegal address, 11-5
- IN 1 70620B softkey, 3-50, 3-67
- independent element
  - addressing, 11-4
  - definition, 11-4
- independent, MMS term, 11-2
- initial commands, 4-5
- initializing
  - receiver personality, 4-2
  - receiver program, 8-17
- INSERT or ... softkey, 3-53, 3-57
- installing
  - into HP 71209A Option 001, 1-14
  - Option 011, 1-12
  - receiver personality, 1-31
  - standard instrument, 1-2
  - INSTR**), 3-56, 7-9
  - INSTR PRESET**), 7-9
- instrument
  - MMS term, 11-2
  - preset, 3-4, 4-5, 7-9
  - returning to spectrum analyzer mode, 3-18
  - switching between modes, 3-16
  - windows, 3-56
- interrupt process, 4-8
- INTRNL MEMORY softkey, 3-53, 3-55, 7-10, 7-13, 7-15
- I/O error status indicator, 9-6
- I OFFSET softkey, 3-27, 7-8
- IP**), 3-4
- IQ**
  - demodulation, 3-26
  - gain and offset, 3-27
  - softkey, 3-27, 7-10
- ISM1-A instrument marking, ix
- ISO/IEC, 5-17

**K**

- keyboard, 3-53, 3-57

**L**

- LAST STATE softkey, 3-18, 7-10
- least significant bits, 11-4
- legal addresses, 11-4
- limit lines, 3-4
- LINEAR softkey, 3-7
- line-power cables, 10-3
- local control, 4-6
- LOCAL key, 4-6
- locating signals, 3-5
- LOG dB/DIV softkey, 3-7
- LSN status indicator, 9-6

**M**

- mainframe, MMS term, 11-2
- maintaining the receiver, 1-28
- markers
  - activating normal markers, 7-11
  - disabling all markers, 7-11
  - entering receiver mode, 3-16
  - moving signals, 3-8
  - positioning, 7-11
  - to next highest peak, 7-11
- MAS/SLA, switches, 11-13
- master
  - address switches, 11-12
  - definition, 11-4
  - elements, 11-6
  - function as a slave, 11-13
  - function as a sub-master, 11-13
  - MMS term, 11-2
- master/slave address matrix, 11-6
- measurement examples, 3-29
  - digital transmission, 3-38
  - pulsed RF signals, 3-29
  - pulsed RF signals in manual mode, 3-46
- memory
  - recalling files, 7-13
  - selecting an HP-IB disk, 7-7
  - selecting external memory, 7-7
  - selecting internal memory, 7-10
  - selecting storage device, 7-7
- MENU**), vii, 7-10
- menu map, 6-2
- messages
  - error, 9-1
- microwave preselector, 3-43, 7-11
  - bandwidth, 3-20
  - bypassing, 3-64
- Misc softkey, 7-10
- MMS term
  - element, 11-2
  - independent, 11-2
  - instrument, 11-2

- mainframe, 11-2
- master, 11-2
- module, 11-2
- slave, 11-2
- stand-alone instrument, 11-3
- sub-master, 11-2
- modulation identification, vi
- module
  - MMS term, 11-2
- monitoring system operation, 4-8, 4-10
- most significant bits, 11-4
- MSIB Y-cable
  - connecting to an MMS mainframe, 1-9

## N

- NARROW SPAN softkey, 3-18, 7-10
- NB VID IN connector, 7-10
- NEXT PEAK**, 7-11
- No Element Present, in address map, 11-8
- noise declaration, 5-18
- NORMAL**, 7-11
- NRML/TEST, switches, 11-13
- number, 8-3

## O

- offset, analog IQ, 3-26
- operation, 3-14
  - modes, iv
  - verification, 2-1
- Option 001, 3-16, 3-23, 7-2
- Option 002, 3-16, 3-23
- Option 004, 3-17, 3-25, 3-26, 3-27, 8-16, 8-18, 8-20, 8-21, 8-22
- Option 005, 3-17, 3-25, 3-26, 3-27, 8-13
- Option 007, 3-16, 3-20, 3-23, 7-2
- Option 011, 1-12
- options, 10-2
- OUTPUT statements, 4-5
- output termination, 8-3

## P

- PEAK SEARCH**, 3-9, 7-11
- performance tests, 2-1
- personality, 3-15
  - downconverting without, 3-41
  - exiting, 3-18
- phase information, 3-20
- phase information, preserving, 3-20
- physical dimensions
  - HP 70001A mainframe, 5-16
  - HP 70004A display/mainframe, 5-16
- PLOT**, 7-11
- Possible compression error message, 3-44, 3-66
- preamplifier, using, 7-11

- PREAMP On Off softkey, 3-50, 3-67, 7-11
- preselector, turning off, 3-23
- PRESEL On Off softkey, 3-23, 3-30
- preset instrument, 7-9
- PRINT**, 7-12
- problems
  - flashing ERR indicator, 9-6
- programming
  - commands, 4-2, 8-6
  - example, 4-4
  - fundamentals, 4-1
- “P” system configurations, 1-5
- pulsed RF
  - demodulating, 3-29
  - downconverting, 3-46
- PULSE softkey, 3-17, 3-27, 7-12

## Q

- Q
  - connector, 3-27
  - front panel connector, 7-12
- Q GAIN softkey, 7-12
- Q OFFSET softkey, 3-27, 7-13
- quadrature, 3-26
- QUADRATURE softkey, 3-27, 7-13

## R

- \*RB annotation, 3-10
- RCL RX STATE softkey, 3-55, 7-13
- rear-panel connections
  - option, 1-4
  - Option 011, 1-12
  - Option 011 and Option 001/002, 1-12
  - standard configuration, 1-3
- rear panel, HP 70911A, 3-19
- RECALL**, 7-13
- receiver
  - description, 1-1
  - mode, 3-14
  - Option 011, 3-4
  - personality, 3-16
  - remote control, 4-5
  - status byte, 4-8
- receiver personality
  - reinstalling, 1-31
- receiver state, 3-52
  - deleting, 3-55
  - recalling, 3-55
  - saving, 3-53
- RECEIVR VERSION softkey, 7-14
- reference level, 3-5, 3-14
  - changing, 3-7
  - setting, 7-14
- REF LEVEL**, 3-5, 7-14
- REF LVL**, 3-9

REF LVL softkey, 3-7  
 regulatory information, x, 5-17  
 remote control, 4-6
 

- ASSIGN statements, 4-5
- CLEAR statements, 4-5
- ENTER statements, 4-5
- OUTPUT statements, 4-5
- query, 4-5
- setup procedure, 4-3

 repackaging for service, 1-35  
 REPLACE or . . . softkey, 3-53, 3-57  
 REPORT ERRORS, display menu key, 11-5  
 reporting errors, 11-5  
 RES BW AutoMan softkey, 3-10  
 resetting instrument parameters, 3-4  
 resolution bandwidth, 3-4
 

- decreasing, 3-10
- manual mode, 3-10

 returning for service, 1-35  
 Return to S/A softkey, 3-18, 7-14  
 RF attenuation, 3-20, 3-23, 7-14  
 RF ATTN AutoMan softkey, 3-23, 7-14  
 RF/IF Gain, 3-20, 7-14  
 RF INPUT connector, 3-3  
 RMT status indicator, 9-6  
 row addressing priority, 11-11  
 ROWs 1—3, switches, 11-13  
 RX\_MODE softkey, vii, 3-16  
 RXRMT CHANFILT command, 8-6  
 RXRMT CHANPATH command, 8-8  
 RXRMT DELETERX command, 8-10  
 RXRMT DEMOD command, 8-11  
 RXRMT FMOFF command, 8-13  
 RXRMT IFGAIN command, 8-15  
 RXRMT IGAIN command, 8-16  
 RXRMT INIT command, 8-17  
 RXRMT IOFFSET command, 8-18  
 RXRMT OPTIONS? command, 8-19  
 RXRMT QGAIN command, 8-20  
 RXRMT QOFFSET command, 8-21  
 RXRMT QUAD command, 8-22  
 RXRMT RECALLRX command, 8-24  
 RXRMT SAVERX command, 8-25  
 RXRMT TEMPCOMP command, 8-26  
 RXRMT VERSION? command, 8-27

**S**

safety symbols, ix  
 save & recall softkey, 3-53, 7-15  
 SAVE RX STATE softkey, 3-54, 7-15  
 saving receiver state, 3-53  
 screen
 

- blanking for security, 3-52
- cleaning, 1-28
- titles, 3-57

 searching for signals, 3-4  
 SELECT CHAR softkey, 3-53, 3-57  
 selecting IF filters, 8-8  
 SELECT INSTRUMENT, display menu key, 11-5  
 SENS AutoMan softkey, 3-11  
 serial number, locating, 1-30  
 service, 1-35
 

- foam inserts, 1-35
- repackaging, 1-35
- return to factory, 1-35

 service requests, 4-8  
 setting
 

- HP-MSIB row address, 11-13
- slave area boundaries, 11-7

 setup procedure for remote control, 4-3  
 SIG LVL On Off softkey, 3-28, 7-15  
 signal
 

- collecting, 3-14
- collecting manually, 3-41
- level, 3-20
- searching for, 3-4
- (SIGNAL TRACK)**, 7-16

 single sweeps, 3-12  
 SINGLE SWEEP softkey, 3-12  
 slave
 

- address switches, 11-14
- area boundaries, 11-7
- area of master, 11-11
- definition, 11-4
- element address switches, 11-14
- elements, 11-7
- MMS term, 11-2

 slave configuration, 11-9  
 softkey
 

- descriptions, 7-2
- map, 6-2

 SPACE softkey, 3-53, 3-57  
**(SPAN)**, 3-5, 3-9, 7-16  
 SPAN softkey, 3-18, 7-16  
 specification
 

- collection receiver, 5-3
- search receiver, 5-9

 spectrum analyzer
 

- bandwidth, 3-42
- commands, 4-2
- mode, 3-4

 spinning constellations, 3-39, 3-68  
 SRQ status indicator, 9-6  
 STACK 2 WINDOWS softkey, 3-56  
 stand-alone instrument, MMS term, 11-3  
 stand-alone operation, 1-1  
**(START)**, 3-5  
**(START FREQ)**, 7-16  
 static precautions, 1-15

status indicators, 9-6

- A, 9-6
- ACT, 9-6
- active, 9-6
- E, 9-6
- ERR, 9-6
- HP-IB, 9-6
- I/O error, 9-6
- LSN, 9-6
- RMT, 9-6
- SRQ, 9-6
- TLK, 9-6

STB command, 4-10

stepping the center frequency, 3-13

step size, center frequency, 3-13

**STOP**, 3-5

**STOP FREQ**, 7-16

sub-master

- address matrix, 11-7
- definition, 11-4
- elements, 11-6
- function as a master, 11-13
- MMS term, 11-2

sweep

- controlling, 3-12

sweep time, 3-12

switches

- A1—A5, 11-14
- COLUMNS 1—5, 11-13
- HP-IB ON/OFF, 11-13, 11-14
- MAS/SLA, 11-13
- NRML/TEST, 11-13
- ROWS 1—3, 11-13
- SW1/MEM, 11-13
- SYSTEM CONTROLLER, 11-15
- TALK ONLY, 11-15
- TEST MODE, 11-15

SWPTIME AutoMan softkey, 3-12

syntax

- argument, 8-2
- terminator, 8-2

Sys Offset > 100mV , 9-4

SYSTEM CONTROLLER, switches, 11-15

system operation monitoring, 4-8

## T

TALK ONLY, switches, 11-15

temp compens softkey, 7-16

temperature compensation, 3-3

terminators, 8-2

TEST MODE, switches, 11-15

TEST position, hard reset, 11-13

three dimensional waterfall display, 3-4

titles, 3-52, 3-57

TITLE softkey, 3-57, 7-17

## Index-8

TLK status indicator, 9-6

trace data units, 8-3

troubleshooting, 9-1

- HP 70207A PC Display for MMS, 9-1
- MSIB interface card, 9-1
- MSIB Y-cable, 9-1

## U

**U**, 7-4

UNCAL error message, 3-12, 3-44, 3-64, 3-65

UNCOR, error message, 3-68

UNCOR error message, 3-44, 3-63

units, 8-3

- dBm, 3-7
- watts, 3-7

units menu softkey, 3-7, 3-28, 7-17

**U**, 7-4

upgrading an HP 71209A, 1-14

Usable RBW limited error message, 3-44, 3-64

Usable VBW limited error message, 3-65

**USER**, 3-16, 7-17

**USER**, 3-15

## V

variable, 8-3

\*VB annotation, 3-11

VBW/IFB RATIO softkey, 3-22, 7-17

ventilation requirements, iii

VID AVG On Off softkey, 3-11

VID BW AutoMan softkey, 3-11, 3-22, 7-17

video bandwidth, 3-14, 3-22

- filtering, 3-11
- manual mode, 3-11

video bandwidth to resolution bandwidth ratio, 7-17

VIDEO connector, 3-27, 7-17

VID OUT TO L.O. connector, 7-17

VOLT softkey, 7-18

## W

WARN 16003, 3-64

WARN 16004, 3-65

WARN 16007, 3-66

warning symbol, ix

warranty, xi

WATT softkey, 3-7, 7-18

WB VID IN connector, 7-18

WB VID OUT connector, 7-18

wide-bandwidth

- digital transmissions, 3-38
- FM signal, 3-34

## Z

zero span operation, 3-14